

Central Agricultural Development Institution

# Kendriya Krishi Vikas Sansthan

(An Autonomous Body Undertaking By  
Government Of India As “Central Agency”)



# CENTRAL AGRICULTURAL DEVELOPMENT INSTITUTION

**Organization Category** : Public Sector Central PSU  
**Organization Type** : Government Organization As Central Agency  
**Sector** : Agriculture and Allied Sector

**Global Central Office** : Uttar Pradesh, India (Owned By CAGDI)  
**State Head Quarter U.P. or Correspondence Office** : CAGDI Building, First Floor, Madhar Mau, Sultanpur Road, Lucknow, Uttar Pradesh, India 226002  
**Proposed Economical or Revenue or Financial Head Quarter Governed By Global Central Office** : Mumbai, Maharashtra, India  
**Proposed (Owned) Central Head Quarter Governed By Global Central Office** : Greater Noida, Gautam Budhha Nagar, Uttar Pradesh, India  
**Dist.Adm.Office Address** : Cabin No. 01, New Garaura, Mansarovar Yojana, Near Shaheed Path, Lucknow, Uttar Pradesh , India 226002  
**Mobile Number** : +91 9532725730  
**Organization Email** : cagdi.india@gmail.com. upagdi.up@gmail.com, director@cagdimail.in  
**Website URL** : <https://www.cagdi.in/>, <https://www.cagdi.org.in/>, <https://www.upagdi.com/>

**Organization PAN** : AABCU9239P  
**IEC Certificate/License No.** : AABCU9239P, KNPIECPAMEND00005994AM2326/08/2022  
**GSTN** : 09AABCU9239P1ZH  
**TAN** : LKNK09124D  
**FSSAI License Number** : 12722999000209  
**Year of Incorporation** : 2016  
**Email** : director@cagdi.in, director.cagdi@gmail.com  
**Mobile Number** : +91 8887121493/496/498, +91 9532725730

# Introduction

Central Agricultural Development Institution (CAGDI) An Autonomous Body Undertaken by Government of India as "Central Agency" recommended/approved by the state government of Uttar Pradesh for institutional ground level operations in various parts of the state in Agriculture and Allied Sector under Zero Corruption Based Policy (ZCBP) since 2016. In 2018, the Central Government approved an institutional budget proposal. The first budget proposal approved by the government of India was 11,931.80 Crores Indian Rupees (Eleven Thousand Nine Hundred Thirty-One Crore and Eighty Lakhs Rupees Only) from order number 17-1/2018-DP Date 19 September 2018 on behalf of Hon. PM Order PMOPG/D/2018/0296165 Order Date 17 August 2018.

CAGDI Institutional Medicinal Agri Product Scheme (MAPS) approved by State Government Of Uttar Pradesh order number CM-53/58-2019-179/2015 Date 16 April 2019 on the proposal submitted by the Institution to the Honorable Chief Minister, Uttar Pradesh, dated April 16, 2019, in the order of the Directorate's letter no. 233/R.A.M./2019-20 Dated 24 April 2019 under Directorate of Horticulture Department Uttar Pradesh's letter number 76-77 dated 16 April 2019 which was approved by Hon'ble Chief Minister's Office.

In the order of livestock development policy presented by the Honorable Chief Minister of Uttar Pradesh Government by Uttar Pradesh Agricultural Development Institution (presently known/trade name Central Agricultural Development Institution), holiday/other cows have interests or conservation/promotion/protection of animals/other In the order of the order issued by the Livestock Department, letter no. In the order dated 04-07-2018, no objection/acceptance with public interest utility was received. The order of the Uttar Pradesh government was issued through order number 3709/thirty-two-2018 Lucknow dated 5 November 2018.

Continue....

Uttar Pradesh Agricultural Development Institution (presently known/trade name Central Agricultural Development Institution) presented to the Honorable Chief Minister of Uttar Pradesh Government for the solution of agricultural/agricultural part environmental problems DIRECTORATE OF ENVIRONMENTAL DIRECTORATE Uttar Pradesh Letter No. 345/Environment/IRRS/2018 dated June 29, 2018, Uttar Pradesh Pollution Control Board Reference No. 3203-4/C0-6/Sa-66/IRRS/20 dated 23-01-2020, Environment, Forest and Climate Change Section-7 Number 214/81-2019 Lucknow dated 9 July 2019 Departmental proceedings/approval/clearance was received.

Uttar Pradesh Krishi Vikas Sansthan (currently popular/trade name Kendriya Krishi Vikas Sansthan) presented to the Hon'ble Chief Minister, Uttar Pradesh Government to create maximum employment (all categories) or create 100% corruption free servants through various means or To develop the system or to develop transparent educational/educational/educational/other methods, for short/long certification/other courses and training for the formation of honest/national beneficiary servants, order number CM 212/seventy- In the order of 1-2018 Lucknow dated 27 December 2018, Hon'ble Chief Minister level approval was received.

Proposal letter 162/U.P.K.V.No./Lucknow/2018-19 dated 03-10-2018 by Uttar Pradesh Krishi Vikas Sansthan (currently popular/trade name Central Agricultural Development Institution) approved by the Institution in front of Hon'ble Labor and Employment Minister, New Delhi, 1.5 lakh (one and a half lakh) various contract / other posts, Uttar Pradesh government order number 1204/36-3-201889(C)/2018 dated July 17, 2018 and order number 1435 /36-3-2018-89( S)/2018 dated August 27, 2018, approval was received after completing all the departmental proceedings.

Under the Industrial Investment and Employment Promotion Policy - 2017 (No-22/2017/869/18-2- 2017-80(LU)/2017) Uttar Pradesh Krishi Vikas Sansthan (current trade name Kendriya Krishi Vikas Sansthan) has been given to the Government of Uttar Pradesh. Issued from Mandate No. 2849/77-62020-L.C. In the order of 61/2017 dated 28 September 2020, Uttar Pradesh Krishi Vikas Sansthan (current trade name Central Agricultural Development Institution) and Horticulture and Food Processing Department, Uttar Pradesh Lucknow on behalf of the State Government of Uttar Pradesh have issued letter no. In the order of 19-21 /2018-19 dated April 06, 2018, the farmers' service center/mini collection center proposed to be established at an institutional at minimum / other support price for the agricultural raw/other products (included in the institutional scheme) of the identified / registered farmers. Ensuring procurement through artificial intelligence at Milk Collection Centre, increasing the availability of self-employment while creating employment in rural areas.

Continue....

CAGDI Institutional purchase of Agri and Allied sector produce will be ensured on MSP/MSOP with ODOP by setting up Farmers' Service Centres for registered institutional farmers at Nyay Panchayat/Gram Sabha level. Provision has been made for the establishment of institutional chilling/warehouse for proper maintenance and management of all the raw materials purchased. In the order of the above, in the order of the Government of Uttar Pradesh, Order No. 170/29-5-2018/5 (1)/18- TC, District Food Marketing Officer Lucknow letter No. 789/IGRS/2017 dated 30-10-2017 Approval of IGRS Reference Number 12157180079853 issued from Commissioner Food, Additional Chief Secretary/Principal Secretary Food and Logistics Department and Hon'ble Chief Minister's Office in the order of letter marketing officer Lucknow/01/IRR/2018 dated 03-04-2018.

CAGDI proposed Institutional 01 Mega Food Park under Pradhan Mantri Kisan Sampada Yojana with ODOP on behalf of Ministry of Food Processing Industries, Government of India order number P12033/69/2019-PC Dated 07/11/2019. Action is in progress on various proposals submitted by Kendriya Krishi Vikas Sansthan to the Central Government.

# Schemes/Projects/Policies of Central Agricultural Development Institution

1. Milk Entrepreneurship Development Program
2. Uttar Pradesh Milk Policy-2018
3. Minimum Support/Other Value Plan/Project
4. Zero Corruption Based Policy
5. One District One Product Scheme
6. Non NPA Agricultural Banking Guarantee Scheme
7. AYUSH Mission

# Schemes/Projects/Programs of Central Agricultural Development Institution

1. Procurement policies relating to agriculture and allied sectors
2. Medicinal Agricultural Product Programs
3. Livestock such as cow protection / promotion / other programs
4. Environmental Improvement Programs
5. Higher/Other Academic/Training Programs
6. Employment or Self-Employment Programs
7. Government Industrial Programs
8. Rural Migration Elimination Programs
9. Three type/tier monitoring program/scheme of/with zero corruption based policies etc.
10. Govt. Employment Generation Programs for Non-Corruption Servants
11. National/International Investment/Marketing Programs such as National/International Import/Export Program

# CAGDI Action Plan

1. Eradication of predicament encountered by agriculturists, allaying sentiment leading to suicide of the agriculturists somehow on the other attributable to fiscal distress.
2. Minimization of rural to urban migration through development of rural occupation.
3. Preserve the fertility or crop yielding capacity of rural agricultural land.
4. Re-enforce animal husbandry programme through this the fecundity of the cows (native breed) and other milch animals will be improved.
5. Enhance milk production complying with market demands/supply.
6. To curb environment hazards, and prompt and circumstances bases empowerment/skilling of agriculturists for their due competence to tackle all existing and emerging odds.

Provisioned structure for establishment of Central Agricultural Development Institution "Kendriya Krishi Vikas Sansthan"(An Autonomous Body Undertaking By Government Of India As "Central Agency").

Establishment of central government based @83 divisional/zone level higher industrial unit of Uttar Pradesh & other states divisional/zonal level industrial unit with Milk processing units, Teaching/Training/ Research Center/Institute or Training/Academical/Educational Unit, Banking/ Financial institution, Pulses/Oilseeds processing unit or Agri Produce raw material processing unit for ODOP & Oher Agri Product, fruit/vegetable processing/other units collectively as five stages in FY 2022-23 to 2028-29 respectively is provisioned by Central Agricultural Development Institution "Kendriya Krishi Vikas Sansthan"(An Autonomous Body Undertaking By Government Of India As "Central Agency").

The plans or projects or policies of the Central Agricultural Development Institution will be subject to change from time to time on the basis of geographical or seasonal or other changes to establish India as an internationally developed nation.

Central Agricultural Development Institution has all rights reserved.



# Action Plan FY 2022-23 to 2028-29

Schemes/Projects for implementation by Central/ State Government or Institution Or jointly by institution with zero corruption based institutional policy.

1. Under the Dairy Entrepreneurship Development Scheme or milk policy or proposed dairy development departmental u.p.milk policy-2018 or other scheme/schemes of dairy and agriculture policy, government of India and/or MAPS,MSP/MSOP,ODOP,Milk or Animal based, Grade Based institutional scheme/Schemes, the @3.5 number of farmers or landless belonging to very poor/ poor/medium weak class (bank turn-over based) of each gram Sabha of Uttar Pradesh state is focused upon under the different scheme/schemes for farmer and/or landless that helps making their best income generation or double/four times/eight times/other ( Bank turnover based) income to build strong farmers or public by putting a total stop on the construction of freebies.
2. marking/registering them under the grade system for the landless laborers / people by the Central Agricultural Development Institution, and with providing them income generation stream through this removed them from the category of weaker income class people / laborers and reach them in the category of strong income class.
3. By marking / registering the farming class / others by the Central Agricultural Development Institute, zero corruption of the minimum scheme, under the policy-based scheme / scheme, through the system without intermediary, Nyaya Panchayat, Central CPPS. Under the system, under the supervision of C.C.T.V , there is a provision to eliminate the middleman practice by purchasing method of agricultural / dairy products / food grains, as well as to increase the income of the strong income farmers (registered farmers) under medicinal products scheme.
4. fertilizers (all categories like chemical / organic products), seeds, agricultural plants etc. for farmers / other members registered at Nyaya Panchayat level Farmers Service Center / Mini Collection Center / Milk Collection Center by Central Agricultural Development Institute. Benefit direct Transfer) is provided under the scheme.
5. Safety of Cold Storage, Dairy Unit, Vermicompost Unit, Calf / Calves (Cow / Buffalo Calf / Calf) in the State of Uttar Pradesh under D.E.D.S Scheme of Milk and Agriculture Policy Bharat Sarkar by Central Agricultural Development Institute / Hybrid Unit, Milk Tanker, Private Veterinary Clinic, Dairy Parlor and other direct means to generate about 40 lakh employment share in 4 stages respectively is provisioned.
6. Under the Animal Husbandry Development Policy, it is proposed to increase the usefulness of indigenous cows by increasing their safety / security / promotion.
7. The system of processing of milk and agricultural products etc. is provided by the Central Agricultural Development Institution.
8. The Central Agricultural Development Institute has the provision to make milk and agricultural produce processed products or others to have presence of Indian products on the international market mind.
9. Estimated number of farmers service center/ mini collection center / milk collection centers for purchase at minimum support price of Nyaya Panchayat level paddy / wheat / pulses / oilseeds / vegetables / milk (all raw materials) by Central Agricultural Development Institution "Kendriya Krishi Vikas Sansthan"(An Autonomous Body Undertaking By Government Of India As "Central Agency").

Construction of the Farmer service center/mini collection center/milk collection center project is proposed in fifth stages respectively in FY 2022-23 to 2028-29.

Continue...

The plans or projects or policies of the Central Agricultural Development Institution will be subject to change from time to time on the basis of geographical or seasonal or other changes to establish India as an internationally developed nation.

Central Agricultural Development Institution has all rights reserved.

# Action Plan FY 2022-23 to 2028-29

The Institution has provided to the State of Uttar Pradesh the Agricultural Product Processing Unit, Banking/Financial (Teaching/Training & Service) Unit, Cow Protection Home Unit, Insurance (Teaching/ Training & Service) Unit, Agricultural Plant (Teaching/Training, Construction) Aces, Organic/Chemical Fertilizer (Teaching/Training Manufacturing) Unit, Research (Agricultural Product Hybridization, Cow Hybridization, Organic Hybridization etc.) Unit, Regular rates stall/unit/milk refrigeration Home/Dairy Products processing unit/of the estimated number of building broad -level joint large industrial unit or institution in the state of Uttar Pradesh & Other States Or/And District wise Micro/Small/Medium Industrial Unit with Cluster based for ODOP and Other Scheme/s = @83 + @655 = @738

NON-NPA KRISHAK BANKING GUARANTEE SCHEME and Dairy Entrepreneurship Development Scheme(D.E.D.S and Other Milk Scheme/s) or other milk based policy or scheme/schemes are implemented by Central Agricultural Development Institution under Zero Corruption Based Policy at Mandal/Tehsil/District/ Nyaya Panchayat / Gram Sabha Level Small Industrial Units (Granted) = @50000

Credit limit on small scale industrial units (subsidized sources to department of animal husbandry, dairies & fisheries ministry of agriculture and farmer welfare order file no.17-1/2018 dated 19-09-2018 )= @ 66.20 lakhs per unit (combined cold storage, dairy units with a daily capacity of 5000 liters, milk processing equipment).

Estimated number of district/tehsil level direct/ indirect (including agency etc.) for processing pure raw milk under the control of Central Agricultural Development Institution =@ 813

District/Tehsil level direct/indirect (including agency etc.) loan for processing pure raw milk under the control of Central Agricultural Development Institution = @4 lakh per unit (Under state level loan scheme or others with non npa krishak banking guarantee scheme/schemes).

Under the control of Central Agricultural Development Institution(till loan payment) D.E.D.S and Other Milk Scheme/s Estimated number of dairy parlors dairy under the plan = @ 27000

Loan on dairy parlors under the scheme (subsidized) = @3 lakhs per dairy parlorder the control of Central Agricultural Development Institution (till loan payment) D.E.D.S and Other Milk Scheme/s. Number of animal clinics under the plan = @ 14700

Loan on animal clinics under the scheme (subsidized) = @ 4. 60 lakhs per animal clinic

Under the control of Central Agricultural Development Institution (till loan payment) D.E.D.S and Other Milk Scheme/s Estimated number of milk tankers under the plan = @ 125

Milk tankers loan under the scheme (subsidized) = @ 26. 50 lakhs per tanker

Estimated number of Farmers Service Centers/Mini Collection Centers/Milk Products Procurement Centers = 8137 under Central Agricultural Development Institutional control (including through agency etc.)

Estimated number of vermicompost units under DEDS scheme under control of Central Agricultural Development Institution (till loan payment) = @ 27000

Loan on vermicompost unit under the scheme (subsidized) = 25200

Central Agricultural Development Institution under control (till loan repayment) of loans subsidized for hybrid animals under D.E.D.S and Other Milk Scheme/s plan= @ 40.40 lakh farmers (marginal or weak income poor farmers to higher income farmers)

D.E.D.S and Other Milk Scheme/s by Central Agricultural Development Institution Loans for hybrid animals under the scheme (subsidized) = @70000

Estimated unit number of calf/calves/other (for cows / buffaloes)of hybrid animals under the scheme = @14000

Loan (subsidized) on the estimated units of calf / calves / other (for cows / buffaloes) of hybrid animals under D.E.D.S and Other Milk Scheme/s scheme = @ 9.70 lakhs per unit for 20 calves

**NOTE-All credit/loan scheme/schemes of institution under the non npa krishak banking guarantee scheme/s.**

The plans or projects or policies of the Central Agricultural Development Institution will be subject to change from time to time on the basis of geographical or seasonal or other changes to establish India as an internationally developed nation.

Central Agricultural Development Institution has all rights reserved.

**Action Plan FY 2022-23 to 2028-29**  
**Under the Dairy Entrepreneurship Development Scheme (D.E.D.S and Other Milk Scheme/s), the amount subsidized on the loan obtained by DBT**

For General Category = @25%

S C / S T / O B C = @33. 33%

Estimated number of jobs created by the Central Agricultural Development Institution in the state of Uttar Pradesh through contract or other means = @1. 5 lakhs

Number of sanctioned posts = @36916

Number of indirectly created employment through Central Agricultural Development Institution = @5.25 lakh

Estimated number of marginal or very poor farming/other farmer/s/other registered families member benefited through Central Agricultural Development Institution BY DBT =@40.40 lakh or total no. of All states =@3.5 Crore

Estimated registered @3.5 crore Krishak or other family or families will nominate with direct benefit transfer scheme/schemes agricultural families

All the policies of the Central Agricultural Development Institution will be variable in the order of the farmer / people / nation / institution beneficial schemes.

## Action Plan FY 2022-23 to 2028-29

### MARKETING / SALES UNIT

The details of the estimated number of Smart Cities / Mandal / District / Tehsil / Block Nyaya Panchayat / Town Area / Other Level Potential Marketing Sales Units of India by the Central Agricultural Development Institution: -

Potential Mass Marketing Unit = @**3705**

Estimated number of potential jobs in the mass marketing unit = @**9,26,250 (250 employees / officers / others per unit)**

Potential Small Marketing Unit = @ **7125**

Estimated number of potential employment in potential small marketing unit = 10,68,750 (150 employees / officers / others per unit)

Potential Macro Marketing Unit = @ **8137**

Estimated number of potential jobs in potential large marketing units = @**24,411 (03 employees / officers / others per unit)**

Potential Other Marketing Sales Unit Number = @**9533**

Estimated number of potential jobs in potential other marketing sales units = @**1,42,955 (15 employees / officers / others per unit)**

Total estimated number of potential jobs in Marketing Sales Unit = @**21,62,406**

Estimated number of livestock house / animal protection home / institutional veterinary hospital / biological power plant / institutional arge vermicompost unit / cow cattle (livestock) cadaver house under livestock policy for Uttar Pradesh

Estimated number of employment in Divisional level Cow Protection Home / Animal Protection Home = @ **975 \* 2 = 1950**

Estimated number of employment in District level Small Cow Protection Home / Animal Protection Home = @ **475 \* 16 = 7600**

Estimated number of employment in District level large institutional veterinary hospital = @ **975 \* 2 = 1950**

Estimated number of employment in District Level Small Institutional Veterinary Hospital = @ **475 \* 16 = 7600**

Estimated number of employment in District level large power plant = @ **975 \* 2 = 1950**

Estimated number of employment in District level small power plant = @ **475 \* 16 = 7600**

Estimated number of employment in the District level Large Institutional Vermicompost Unit = @ **975 \* 2 = 1950**

Estimated number of employment in District Level Small Institutional Vermicompost Unit = @ **475 \* 16 = 7600**

Estimated number of employment in District level bovine (livestock) crematorium = @ **40 \* 18 = 720**

## Action Plan FY 2022-23 to 2028-29

### Medicinal Agricultural Product Scheme

The Central Agricultural Development Institution has a provision of providing credit to farmers in all the regions of India, by providing them credit facilities, such as = 10,000 per acre of credit, and to provide them training of medicinal agricultural plants free of cost, for which the Institution has been identified / registered. Ensuring availability of high quality fertilizers / seeds / others to farmers that has been produced by farmers medicinal agricultural products (Raw Material) selling produce materials not less than half price fixed by the government of india to support the farmers or will provide them one and a half time more price than the money they spend on their farm . There are 140 plants that came under the category of medicinal plants and to motivate the farmers to indulge in the farming of medicinal plants there is a provision of providing them subsidy of @ 30%, @ 50%, @ 75% under the Ministry of AYUSH Government of the Ministry of AYUSH Medicinal Plants Mission, respectively, as prescribed by the Ministry of AYUSH Ministry of India, on the production of registered medicinal agricultural products. The system of direct transfer is a provision under the zero corruption based policy.

Free medicinal training to farmers, registered / identified by the Institution (under Medicinal Agricultural Products Scheme) for medicinal agricultural products / seed manure / others by providing facility to farmers registered / identified under Medicinal Agricultural Products Scheme on the basis of timely changes or others. Providing sowing, irrigation, harvesting, subsequent purchase and purchase of return (including interest) Return via the selling of their produced materials (registered / marked the medicinal product by the agricultural farmers) (raw material for all category) provisions are ensured.

The Medicinal Agricultural Produce Scheme will be variable based on seasonal changes. Expenditure incurred on seeds, sowing, irrigation, harvesting and other expenses on the farmers will be refunded from the funds received by the Institution from the credited / identified farmers after the sale by the Institution, ie from the funds received / sold by the Institution. Product plan or medicinal plant mission for ministry of AYUSH India) Plan on the basis of seasonal / geographical changes No will be provided. Panchakarma unit under the Medicinal Plant Mission in which K.G.M.U (Medical College Lucknow) and Uttar Pradesh Agricultural Development Institution changed name Panchakarma unit to be established by Central Agricultural Development Institution etc.

Estimated number of district level registered high / medium / marginal farmers under medicinal scheme = @ **10000**

Estimated cost (in Rs.) on credit with credit given to district level registered high / medium / marginal farmers under medicinal scheme = **Rs.15000 to @ Rs.20000** per farmer or cost per bigha (either one)

Estimated income per district of high / medium / marginal farmers registered under medicinal scheme = @ **50000 to @ 70000**.  
District level registered annual yield in 1 bigha land by medicinal scheme registered high / medium / marginal farmers = @ **2**

The plans or projects or policies of the Central Agricultural Development Institution will be subject to change from time to time on the basis of geographical or seasonal or other changes to establish India as an internationally developed nation.

Central Agricultural Development Institution has all rights reserved.

# Civic Duty

Corruption is basically an obstacle in the establishment of an internationally developed nation of India. On the basis of various research, the bribe giver is more guilty and hated than the bribe taker. Bribery / extortionist, using various means / options etc. to bribe / extort officers / officers / employees / employees etc. Only after the complete stop of which India can be established as a developed nation at the international level, then the Central Agricultural Development Institution will basically strictly implement the zero corruption based policy. Central Agricultural Development Institution expects / appeals to every citizen of the nation of India to provide their full cooperation to the institution or to the nation / state etc.

## Goals

Central Agricultural Development Institution (CAGDI) aims to doubling or other increased income of Indian Farmers and boosting Indian Economy Growth or GDP on Global scale, with actual implementation of Central/State Governments and CAGDI Schemes or Joint schemes, for Farmers and Skilled/Semi-skilled/Non-skilled Labours of India. Establishment of the nation of India at the international level, to bring inflation down to the lowest level, establishment of agriculture and allied sectors/farm level large/micro/medium/ small government industrial units in rural areas or district level cluster development etc., Agriculture and allied To represent the nation of India in a global market system through regions/farm level food products etc.

The plans or projects or policies of the Central Agricultural Development Institution will be subject to change from time to time on the basis of geographical or seasonal or other changes to establish India as an internationally developed nation.

Central Agricultural Development Institution has all rights reserved.

# **Kendriya Krishi Vikas Sansthan**

(CENTRAL AGRICULTURAL DEVELOPMENT  
INSTITUTION)

(An Autonomous Body Undertaking By Government Of  
India As “Central Agency”)

## **DETAILED PROJECT REPORT (DPR)**

FINANCIAL YEAR 2022-23 to 2028-29

**Prepared By – CAGDI Investment Division**

## INTRODUCTION

Central Agricultural Development Institution (CAGDI) An Autonomous Body Undertaken By Government Of India As “Central Agency” recommended/approved by the state government of Uttar Pradesh for institutional ground level operations in various parts of the state in Agriculture and Allied Sector under Zero Corruption Based Policy (ZCBP) since 2016. In 2018, Central Government approved institutional budget proposal. The first budget proposal approved by government of India was 11,931.80 Crores Indian Rupees (Eleven Thousand Nine Hundred Thirty One Crore and Eighty Lacs Rupees Only) from order number 17-1/2018-DP Date 19 September 2018 on behalf of Hon. PM Order PMOPG/D/2018/0296165 Order Date 17 August 2018.

CAGDI Institutional Medicinal Agri Product Scheme (MAPS) approved by State Government Of Uttar Pradesh order number CM-53/58-2019-179/2015 Date 16 April 2019 on the proposal submitted by the Institution to the Honorable Chief Minister, Uttar Pradesh, dated April 16, 2019, in the order of the Directorate's letter no. 233/R.A.M./2019-20 Dated 24 April 2019 under Directorate of Horticulture Department Uttar Pradesh's letter number 76-77 dated 16 April 2019 which was approved by Hon'ble Chief Minister's Office.

In the order of livestock development policy presented by the Honorable Chief Minister of Uttar Pradesh Government by Uttar Pradesh Agricultural Development Institution (presently known/trade name Central Agricultural Development Institution), holiday/other cows have interests or conservation/promotion/protection of animals/other In the order of the order issued by the Livestock Department, letter no. In the order dated 04-07-2018, no objection/acceptance with public interest utility was received. The order of the Uttar Pradesh government was issued through order number 3709/thirty-two-2018 Lucknow dated 5 November 2018.

Uttar Pradesh Agricultural Development Institution (presently known/trade name Central Agricultural Development Institution) presented to the Honorable Chief Minister of Uttar Pradesh Government for the solution of agricultural/agricultural part environmental problems DIRECTORATE OF ENVIRONMENTAL DIRECTORATE Uttar Pradesh Letter No. 345/Environment/IRRS/2018 dated June 29, 2018, Uttar Pradesh Pollution Control Board Reference No. 3203-4/C0-6/Sa-66/IRRS/20 dated 23-01-2020, Environment, Forest and Climate Change Section-7 Number 214/81-2019 Lucknow dated 9 July 2019 Departmental proceedings/approval/clearance was received.

Uttar Pradesh Krishi Vikas Sansthan (currently popular/trade name Kendriya Krishi Vikas Sansthan) presented to the Hon'ble Chief Minister, Uttar Pradesh Government to create maximum employment (all categories) or create 100% corruption free servants through various means or To develop the system or to develop transparent educational/educational/educational/other methods, for short/long certification/other courses and training for the formation of honest/national beneficiary servants, order number CM 212/seventy- In the order of 1-2018 Lucknow dated 27 December 2018, Hon'ble Chief Minister level approval was received.

Proposal letter 162/U.P.K.V.No./Lucknow/2018-19 dated 03-10-2018 by Uttar Pradesh Krishi Vikas Sansthan (currently popular/trade name Central Agricultural Development Institution) approved by the Institution in front of Hon'ble Labor and Employment Minister, New Delhi, 1.5 lakh (one and a half lakh) various contract / other posts, Uttar Pradesh government order number 1204/36-3-2018-89(C)/2018 dated July 17, 2018 and order number 1435 /36-3-2018-89( S)/2018 dated August 27, 2018, approval was received after completing all the departmental proceedings.



Under the Industrial Investment and Employment Promotion Policy - 2017 (No-22/2017/869/18-2-2017-80(LU)/2017) Uttar Pradesh Krishi Vikas Sansthan (current trade name Kendriya Krishi Vikas Sansthan) has been given to the Government of Uttar Pradesh. Issued from Mandate No. 2849/77-6-2020-L.C. In the order of 61/2017 dated 28 September 2020, Uttar Pradesh Krishi Vikas Sansthan (current trade name Central Agricultural Development Institution) and Horticulture and Food Processing Department, Uttar Pradesh Lucknow on behalf of the State Government of Uttar Pradesh have issued letter no. In the order of 19-21 /2018-19 dated April 06, 2018, the farmers' service center/mini collection center proposed to be established institutional at minimum / other support price for the agricultural raw/other products (included in the institutional scheme) of the identified / registered farmers. Ensuring procurement through artificial intelligence at Milk Collection Center, increasing the availability of self-employment while creating employment in rural areas.

CAGDI Institutional purchase of Agri and Allied sector produce will be ensured on MSP/MSOP with ODOP by setting up Farmers' Service Centers for registered institutional farmers at Nyay Panchayat/Gram Sabha level. Provision has been made for the establishment of institutional chilling/warehouse for proper maintenance and management of all the raw materials purchased. In the order of the above, in the order of the Government of Uttar Pradesh, Order No. 170/29-5-2018/5 (1)/18-TC, District Food Marketing Officer Lucknow letter No. 789/IGRS/2017 dated 30-10-2017 Approval of IGRS Reference Number 12157180079853 issued from Commissioner Food, Additional Chief Secretary/Principal Secretary Food and Logistics Department and Hon'ble Chief Minister's Office in the order of letter marketing officer Lucknow/01/IRR/2018 dated 03-04-2018.

CAGDI proposed Institutional 01 Mega Food Park under Pradhan Mantri Kisan Sampada Yojana with ODOP on behalf of Ministry of Food Processing Industries, Government Of India order number P-12033/69/2019-PC Dated 07/11/2019. Action is in progress on various proposals submitted by Kendriya Krishi Vikas Sansthan to the Central Government.

## **GOALS**

Central Agricultural Development Institution (CAGDI) aims to doubling or other increased income of Indian Farmers and boosting Indian Economy Growth or GDP on Global scale, with actual implementation of Central/State Governments and CAGDI Schemes or Joint schemes, for Farmers and Skilled/Semi-skilled/Non-skilled Labours of India.

## **ADMINISTRATIVE OFFICES**

Cabin No.01 New Garaura Maan Sarover Yojna Sector-O Near Shaheed Path Lucknow, Uttar Pradesh, India 226002, and Central Administrative Office proposed in Lucknow and Central Head Quarter Proposed in Greater Noida and Central Financial Head Office proposed in Mumbai, as state headquarter of Uttar Pradesh is Block 'B' 6th floor Pick-Up Bhawan Vibhuti Khand Lucknow-226010

## **WORKING HOURS**

Industrial Division Working Hours are 24x7

Public Interest Local Office Hours are 24x7

Administrative/Managerial Office Hours 24x5

## **MISSION**

The mission statement of CAGDI is as under:

1. Eradication of predicament encountered by agriculturists, etc./ Allaying the sentiment leading to suicide of the agriculturists somehow or the other attributable to fiscal distress.
2. Minimization of rural to urban migration or development of rural occupation.
3. Preserve the fertility or crop yielding capacity of rural agriculture land.
4. Re-enforce animal husbandry program.
5. Enhance Milk production complying with market demands.
6. To curb environmental hazards, and prompt and circumstances based empowerment /skilling of agriculturists for their due competence to tackle all existing and emerging odds.

## **MISSION MODE (Web 3.0 Governance Globalization)**

1. Real Time access to global knowledge at Geo-local level.
2. Augmented reality at local level.
3. Rationing for Locomotion.
4. Energy and food at local level.
5. Normalization of price crisis.
6. Recycling of natural resources at smart city/village level.
7. Augmented platform to enhance individual to carry out own dream endeavour on its own in mechanical social assisted environment.
8. Clean fuel usage for operations/development.

## **CAGDI Specialization**

The main features of the schemes or projects or joint schemes or projects of Uttar Pradesh State Government or State Governments, Central Government and Institution run by Central Agricultural Development Institution: Institutional government industrial unit construction or government infrastructure development Inclusion of non-performing KCC assets of small/marginal/medium/very low income farming classes in institutional schemes To provide support in providing social/economic security to small/marginal/medium very low income farmers or landless people by including them in institutional schemes. Market arrangement with level of artificial intelligence for purchase of agricultural and allied food products at minimum support prices and for essential commodities for use in agricultural works for farmers, Nyay Panchayat etc. Representing the natural nature of India in the international market as per international standards-Environmental protection contribution Complete stop on the loss of various mediums of agricultural raw material production - creation of direct government jobs in agriculture and allied sectors or creation of direct/indirect self-employment and employment in rural areas in agriculture and allied sectors or in agriculture and food processing sectors.

## **CAGDI Features**

The main features of the schemes or projects or joint schemes or projects of Uttar Pradesh State Government or State Governments, Central Government and Institution run by Central Agricultural Development Institution:

- Institutional government industrial unit construction or government infrastructure development.
- Inclusion of non-performing KCC assets of *small/marginal/medium/very low income farming classes* in institutional schemes.
- To provide support in providing social/economic security to small/marginal/medium very low income farmers or landless people by including them in institutional schemes.
- Market arrangement with level of artificial intelligence for purchase of agricultural and allied food products at minimum support prices and for essential commodities for use in agricultural works for farmers, Nyay Panchayat etc.
- Representing the natural nature of India in the international market as per international standards-Environmental protection contribution
- Complete stop on the loss of various mediums of agricultural raw material production - creation of direct government jobs in agriculture and allied sectors or creation of direct/indirect self-employment and employment in rural areas in agriculture and allied sectors or in agriculture and food processing sectors.

### **CAGDI RESEARCH BRIEFING**

The following facts/reports came to light in view of corruption in physical /other forms of share of agriculture / farmers: Bank loan problem is often the root factor of farmer suicides. The basic reason for rural migration is the lack of accessible agriculture/other system at the village level. Continuous shortage of employment (national/state level) in the departmental/agricultural sector despite the immense possibilities of employment (government jobs and rural employment). Livestock system which may be physically involved in the allied arrangements of agriculture, not to be included in actual or non-compliance of policies. There is no laxity in the rules against corruption for the general public but for the government officials to relax the rules. If caught taking a bribe, then taking a bribe, taking an exemption etc. was seen in the system (government system). Often the agency of physical supervision of the actual implementation of the schemes released by the Central/State Government, etc., was not seen to work on the actual ground. The lack of physical verification of the actual implementation of schemes/projects/policies/mandates/others issued by the Central/State Government was reflected.

### **OBJECTIVES OF INSTITUTION**

1. The project is aimed at training the Ultimate Backward/ Backwards/Middle Class/Krishi Card Holders for no charge regarding scientific agriculture enhancement of qualitative and quantitative of their farm yield and facilitation of seeds, fertilizers, equipment, etc. at market price so that optimum utilization of their own farm capacity could be attained.
2. To form 5 groups or “Samiti” or “SHGS” or independent farmer/landless membership or non performing KCC Assets Assesses in each “Nyaya/Gram Sabha” comprising of 12 members per group aggregating 60 in strength per “Nyaya/Gram Sabha” in order to enable them avail optimum benefits under DEDS (Dairy Entrepreneurship Development Scheme)/U.P.Milk Policy-2018 or other milk policy or schemes/grade scheme/others so that they are at ease to relief themselves from EMI and due satisfaction of the credit repayment is determined through Bhartiya Bank(a joint ventures of Kendriya Krishi Vikas Sansthan). This scheme could be directly availed by agriculturists/farmers, by first tracing or locating the potential beneficiaries, then training them through different modes free of cost.
3. The Scheme incorporates the facility of “Krishak Sewa Kendra or Mini Collection Center or Milk Collection Center” wherein the edible yield or the raw agri product/produce with one district one product scheme (i.e. Milk, Rice, Paddy, Wheat, Pulses, Oil Seeds and other seeds, vegetables etc.)

presented by the farmer member for sale fetches at least the minimum aid Price but not less than Minimum Selling Price (MSP) declared by Government of India.

4. The farm yield purchase will be facilitated via formation of “Krishak Sewa Kendra or Mini Collection Center or Milk Collection Center” at “Nyaya/Gram Sabha” level, under which yield will be paid off to the indebted/other farmer member registered with institution in their respective bank accounts and the financial institution (FI)/Bank concerned within 12 to 32 hours through NEFT/RTGS/Other banking channels in the ratio of 2:3 or 3:2 i.e. or a part of the produce price will be paid directly to the FI(Financial Institution)/Bank and the other portion to be paid off to the farmer member directly in the specified rate of share of 60%: 40% or vice versa, per the above ratio via DEDS (Dairy Entrepreneurship Development Scheme)/other milk based program or schemes/grade schemes/maps or others. This facility will be ensured on all agricultural and allied sector related raw and other produce.

5. To provide technical development or artificial intelligence to the Krishak Sewa Kendra/Mini Collection Center/milk collection center by installation of CCTV Cameras, this will be connected to Headquarter for online monitoring purpose.

6. To provide Milk Chilling Plant/Warehouse/Plant/Flour Processing Unit/Cold Storage and/or others Agri and allied sector product processing Mini/Micro/high Processing Unit at District/Zone or Region/state or international/national or national/state or state/zone/region or region/zone/district level units and others jointly having capacity of daily processing milk of 1.80 lacs ltr to 20 lacs litres or 1.80 lacs mt. to 20 lacs m.t. capacity and mega food park. This will be a revolution in the field of milk and its processing, which will be physically verified within 24 hours and other changeable programmes or scheme/schemes or policy/policies.

7. To provide Mini/Micro/high Processing Unit at District/Zone or Region/state or international/national or national/state or state/zone/region or region/zone/district level units for generation of more employment or jointly generation of employment with rural self employment opportunities.

8. This program will be implemented in 4 phases as per the finance availability/Sources by Central Government/State Government/FDI or FI/Domestic or Public Investment and its subsidiaries and others depending on changeable program.

9. This program/scheme will help in generation of employment of approx 78,298 jobs on Roll in the State of Uttar Pradesh and 3.5 crore self employments by the Institution in the State or all States in India within FY 2022-23 to 2028-29 or changeable based program.

10. To dispose of farmers problems/grievances within 5 working days through development of Artificial Intelligent or Online Web Portal and other changeable programs.

11. This program in the sequence of time, will ensure income of farmers from 2-4 times which will in turn ensure the positive step of India towards developed nations list, by direct or indirect support of agriculture.

## **BENEFITS FROM THIS PROJECT**

1. Actual implementation of Milk and Agriculture/Other Policy of the Government of India and/or State/states government policy.

2. Control over irregularities in Minimum Support Price in milk and milk products/food grains/potatoes (all vegetables)/pulses/oilseeds/paddy/wheat/other agri raw products.

3. Elimination of synthetic milk/adulterated milk and milk products by availability of milk production on the basis of market demand/fulfillment.

4. Elimination of middlemen.

5. Prevention of rotting vegetables/other agri produces damage.

6. Prevention of disenchantment with agricultural works.

## **ASSUMPTIONS OF PROJECT REPORT**

1. There will be 5 groups in each Gram Sabha and each group will comprise 12 farmers.
2. There will be average production of 10 liters of milk per day from each farmer.
3. Minimum Selling Price (MSP) of milk will be Rs. 34.87/- per liter.
4. Each farmer will spend 25% of its income generated for fodder and other maintenance services such as veterinary services of animals.
5. Each farmer will give 60% of its income generated for EMI on loan/credit taken for purchase of animals.
6. Cost of cow and buffalo would be approx Rs. @70,000/- with DEDS/other milk based scheme.
7. Due to unavailability of market set by government at nearby places approx 44% of farmers whose production capacity is not more than 5 quintals and remaining 66% of farmers whose production capacity is not more than 15 Quintals are forced to sell their harvest at less than MSP declared by Government of India.
8. It is assumed that each farmer produces 5 quintal of wheat, 2 quintal of Paddy, 5 quintal of potato, 2 quintal of pulses and 1 quintal of Oil Seeds from 1 beegha land in one year.

# **IMPLEMENTATION PHASE**

## **PHASE 1**

Financial Year 2022-23 TO 2028-29.

Administrative/Industrial(international-level) or Mega Food Park (with Lab And Other Resurch Center or Punchkarm or Other Institutional Based unit) Unit will developed by CAGDI.

## **PHASE 2**

FINANCIAL YEAR 2022-23 TO 2028-29.

Administrative/Industrial(National/State-level) or Lab and other Research Center or Punch karm or other Institutional based unit will developed by CAGDI.

## **PHASE 3**

FINANCIAL YEAR 2022-23 TO 2028-29.

Administrative/Industrial(State/Region or Zone-Level) or Lab and Other Research Center or Punch karm or Other Institutional Based Unit will developed by CAGDI.

## PHASE 4

FINANCIAL YEAR 2022-23 TO 2028-29.

Administrative/Industrial(Region or Zone/District-level) or Lab and Other Research Center or Punchkarm or Other Institutional Based Unit will developed by CAGDI.

### AREAS TO BE FOCUSED

- Agriculture and Allied Sector's Raw/Other Produce.
- Vermicompost, seeds, fertilizer, tools and others.

ANNUAL ESTIMATED INCOME OF EACH FARMER MEMBER

ESTIMATED INCOME FROM MILK PRODUCTION.

Monthly income of each farmer on the basis of above assumptions =  $30 \times 10 \times 34.87 = 10,461/-$

Expense for fodder and other maintenance services =  $10,461 \times 25\% = 2,615/-$

EMI =  $10,461 \times 40\%$   
=4,184/-

Net monthly income after deduction of expenses and EMI  
=  $10,461 - 2,615 - 4,184$   
=3,662/-

Hence, Net Annual Income of each farmer would be  
=  $3662 \times 10$   
=36,620/-

Estimated Bank Loan/credit	70,000/-
Government Subsidy for backward classes (33.33%)	23331/-
Net Amount of Loan to be beared by farmer	46669/-

Rate of Interest (lump sum) @ (8.25-10.25) % for the period of 9 months as per reducing balance method	7000/-
Total payable cost by agriculturists (inclusive of Interest)	53669/-

Note: The NNKBGS (Non NPA Krishak Banking Guarantee Scheme) by the Uttar Pradesh Banking sponsored by Bhartiya Bank (a joint ventures of Kendriya Krishi Vikas Sansthan) or every Nationalized Bank working under DEDS/other milk based Scheme.

#### INCOME GENERATION FROM WHEAT

Average market rate of wheat = 1,300/- per Quintal  
MSP declared by government of Wheat = 1935/- per Quintal

Additional income if 2 Quintal sold on MSP (Benefit from CAGDI MSP/MSOP Scheme)  
= (1935-1300) x 2  
= 635 x 2  
=1270/-

#### INCOME GENERATION FROM PADDY

Average market rate of Paddy = 1,100/- per Quintal  
MSP declared by government of Paddy = 1855/- per Quintal

Additional income if 2 Quintal sold on MSP (Benefit from CAGDI MSP/MSOP Scheme)  
= (1855-1100) x 2  
= 755 x 2  
=1510/-

#### INCOME GENERATION FROM POTATO

Average market rate of Potato = 300/- per Quintal  
MSP declared by government of Potato = 566/- per Quintal

Additional income if 5 quintal sold on MSP  
= (566-300) x 5  
= 266 x 5  
=1,330/-

## INCOME GENERATION FROM VEGETABLE PRODUCED FROM ORGANIC FARMING-

Average income from vegetable production from ordinary methods on 1 beegha land = 10,000/- To 50000/-

After adoption of organic farming method average income on 1 beegha land from vegetable production = 40,000/-

Therefore, difference in income due to organic farming during the period of 6 months = 40,000 - 10,000  
= 30,000/-

Hence, additional income per year  
= 30,000 x 2  
= 60,000/-

## INCOME GENERATION FROM PULSES

Average market rate of Pulses (Raw) = @2,500/- to 3,500/- per quintal

MSP declared by government of Pulses (Raw) = 3,400/-to 6,400/ per quintal

Additional income if 2 quintal sold on MSP= @2,100/- to @3,600/-

## INCOME GENERATION FROM OIL SEEDS

Average market rate of Oil Seeds = @2,700/- to @3700/- per quintal

MSP declared by government of Oil Seeds = @3,200/- to @5600/- per quintal

Additional income if 1 quintal sold on MSP = @1500/- to @2200/-

Total Additional income of each farmer from all sources= Rs.1,02,020/-

## MANPOWER RESOURCES

S. No	Designation	No of Vacancy	Monthly Salary	Total Annual Salary
1	General Manager	1	80,000/-	9,60,000/-



2	Additional General Manager	18	50,000/-	108,00,000/-
3	Deputy General Manager	18	45,000/-	97,20,000/-
4	Chief Engineer	01	50,000/-	6,00,000/-
5	Civil Engineer	18	40,000/-	86,40,000/-
6	Mechanical Engineer	18	40,000/-	86,40,000/-
7	Electrical Engineer	18	40,000/-	86,40,000/-
8	Chief Chemist	01	70,000/-	8,40,000/-
9	Chartered Accountant	02	50,000/-	12,00,000/-
10	Manager	36	28,000/-	1,20,96,000/-
11	Chemist	18	45,000/-	97,20,000/-
12	Additional Manager	36	25,000/-	108,00,000/-
13	Milk Operator	18	20,500/-	44,28,000/-
14	Additional Milk Operator	18	18,000/-	38,88,000/-
15	Fertilizer Operator	18	18,000/-	38,88,000/-
16	Additional Fertilizer Operator	18	18,000/-	38,88,000/-
17	Milk worker	720	12,000/-	1,03,680,000/-
18	Fertilizer worker	720	12,000/-	1,03,680,000/-
19	Joint Director	18	23,300/-	50,32,800/-
20	District Agriculture Manager	75	20,500/-	1,84,50,000/-
21	Additional Director	316	16,800/-	6,37,05,600/-
22	Animal Disease examination officer	316	23,300/-	8,83,53,600/-
23	Food Processing Officer	316	11,998/-	4,54,96,416/-
24	Law Officer	316	16,680/-	6,32,50,560/-

25	Trainer	316	11,998/-	4,54,96,416/-
26	Security Officer	18	50,000/-	1,08,00,000/-
27	Security Guard	594	12,000/-	8,55,36,000/-
28	Monitoring Officer/ Auditor	316	11,998/-	4,54,96,416/-
29	Centre In charge	8137	9,800/-	95,69,11,200/-
30	Farmer Coordinator	8137	5,200/-	50,77,48,800/-
31	Cleaning workers	8207	4,200/-	41,36,32,800/-
32	Weighting workers	8137	4,400/-	42,96,33,600/-
TOTAL Remuneration				30,856,52,208/-
Total Vacancy = 36,916				
Add: Other Miscellaneous Allowances (13%)				40,11,34,787/-
Total Remuneration inclusive of all allowances				3,48,67,86,995/-

Hence, Total Remuneration inclusive of all allowances

NOTE = Rs. **349** crores approx HR for 18(eighteen) National/State Level Administrative/Industrial Unit Estimated Cost For 33(Thirty three months With ZCBP) Budget Passed/Approved By Department of animal husbandry, dairing and fisheries Ministry Of Agriculture Govt.of India.

Note: All rights of recruitment and any changes to be made are reserved with the institution as per its requirements.

[EMPLOYMENT TARGET OF CENTRAL AGRICULTURAL DEVELOPMENT & JOINT VENTURE WITH INSTITUTION FOR FINANCIAL YEAR 2022-23 to 2028-29.](#)

IN UP & Other States on Roll Employee	1,50,000 (In UP 78,298)
---------------------------------------	-------------------------

In Other State on Roll	2600 / State
IN UP & Others States Off Roll Employment	3.5 crore approx (lump sum 0.40 crores approx of non-performing KCC assets of small/marginal/medium/very low income farming classes Farmer Or landless family in UP)
In Other State off roll	N.A.
Total on Roll(Permanent Employment With ZCBP)	1,50,000
Total off Roll	3.5 crore approx

[INSTITUTIONAL PROPOSED AGRI & ALLIED SECTOR RAW PRODUCT FOR PURCHASE ON MSP/MSOP \(NOT LESS THAN MSP\) SHEET CHART](#)

State	Sr.No.	District	Agri & Allied Sector Product	Proposed by CAGDI	Final Product
Andaman & Nicobar Islands	1	Nicobar	Coconut	Coconut based products	Coconut
Andaman & Nicobar Islands	2	North & Middle Andaman	Coconut	Coconut based products	Coconut
Andaman & Nicobar Islands	3	South Andaman	Coconut	Coconut	Coconut
Andhra Pradesh	1	Ananthapuram	Groundnut	Groundnut products	Groundnut
Andhra Pradesh	2	Chittoor*	Mango	Tomato	Tomato
Andhra Pradesh	3	East Godavari	Paddy (Black Rice)	Coconut products	Coconut
Andhra Pradesh	4	Guntur*	Chilli	Spices (Chilli & Turmeric)	Spices (Chilli & Turmeric)
Andhra Pradesh	5	Kadapa*	Banana	Banana	Banana
Andhra Pradesh	6	Krishna	Mango	Mango	Mango
Andhra Pradesh	7	Kurnool	Pomegranate	Onion	Onion
Andhra Pradesh	8	Nellore	Paddy	Citrus	Citrus
Andhra Pradesh	9	Prakasam	Mango	Spices (Chilli & Turmeric)	Spices (Chilli & Turmeric)
Andhra Pradesh	10	Srikakulam	Paddy	Cashew processing	Cashew nut
Andhra Pradesh	11	Visakhapatnam	Turmeric	Sugarcane	Sugarcane
Andhra Pradesh	12	Vizianagaram	Ragi	Mango	Mango
Andhra Pradesh	13	West Godavari	Paddy (Black Rice)	Aqua	Aqua
Arunachal Pradesh	1	Anjaw	Large Cardamon	-	Large Cardamom

Arunachal Pradesh	2	Changlang	-	Arecanut	Arecanut
Arunachal Pradesh	3	Dibang valley	Maize	-	Maize
Arunachal Pradesh	4	East Kameng	--	Orange	Orange
Arunachal Pradesh	5	East Siang (Pasighat)	Mandarin	Orange	Orange/Mandarin
Arunachal Pradesh	6	Kamle	Finger Millet	Orange based product	Orange
Arunachal Pradesh	7	Kra-Daadi	L.Cardamom	L. Cardamom	L. Cardamom
Arunachal Pradesh	8	Kurung Kumey	Large Cardamom	L. Cardamom	L. Cardamom
Arunachal Pradesh	9	Lepa Rada	Chilly	Pickle	Pickle (To be Specified)
Arunachal Pradesh	10	Lohit	Ginger	Sesamum	Sesamum
Arunachal Pradesh	11	Longding	Foxtail Millet	Ginger	Ginger
Arunachal Pradesh	12	Lower Dibang valley	Maize	Turmeric	Turmeric
Arunachal Pradesh	13	Lower Siang	Pineapple	-	Pineapple
Arunachal Pradesh	14	Lower Subansiri	Kiwi	Kiwi	Kiwi
Arunachal Pradesh	15	Namsai	Aromatic Rice	Ginger	Ginger
Arunachal Pradesh	16	Pakke Kesang	Paddy	-	Paddy
Arunachal Pradesh	17	Papum Pare (Yupia)	Ginger	Turmeric	Turmeric
Arunachal Pradesh	18	Shi-yomi	Red Potato	-	Red Potato
Arunachal Pradesh	19	Siang	Arunachal Orange	Large Cardamom	Large Cardamom
Arunachal Pradesh	20	Tawang	Finger Millet	Walnut	Walnut
Arunachal Pradesh	21	Tirap	Foxtail Millet	Millet based products	Millets
Arunachal Pradesh	22	Upper Siang	Ginger	Orange	Orange
Arunachal Pradesh	23	Upper Subansiri	-	Orange based products	Orange
Arunachal Pradesh	24	West Kameng	Tomato	Temperate Fruits	Temperate Fruits ( To be specified)
Arunachal Pradesh	25	West Siang	Red Potato	Pineapple	Pineapple
Assam	1	Baksa	Assam lemon		Honey
Assam	2	Barpeta	Rice	Milk Products	Milk Products
Assam	3	Biswanath Charali	-	Potato	Potato
Assam	4	Bongaiaogaoan	Rice	Turmeric	Turmeric
Assam	5	Cachar	Pineapple	Pineapple	Pineapple
Assam	6	Charaideo	-	Rice Products	Paddy
Assam	7	Chirang	Assam lemon		Assam lemon
Assam	8	Darrang	Rice	Mustard Products	Mustard Products
Assam	9	Dhemaji	-	Mustard Products	Mustard Products
Assam	10	Dhubri	Rice	Chilli	Chilli
Assam	11	Dibrugarh	-	Mustard based products	Mustard
Assam	12	Dima Hasao	-	Ginger	Ginger
Assam	13	Goalpara	Banana	Banana	Banana
Assam	14	Golaghat	-	Black Rice	Black Rice
Assam	15	Hailakandi	-	Arecanut	Arecanut
Assam	16	Hojai	-	Sugarcane	Sugarcane

Assam	17	Jorhat	-	Chilli	Chilli
Assam	18	Kamroop Metro	Mandarin	Fruits and	Fruits and
Assam	19	Kamroop Rural	Pineapple	Banana	Banana
Assam	20	Karbi Anglong	Ginger	Pineapple	Ginger
Assam	21	Karimganj	-	Arecanut/ Betelnut	Arecanut/Betelnut
Assam	22	Kokrajhar	Banana	Mushroom	Mushroom
Assam	23	Lakhimpur	Paddy	Paddy	Paddy
Assam	24	Majuli	Assam Lemon	Mustard oil/seed	Mustard
Assam	25	Morigaon	Honey	Groundnut products	Groundnut
Assam	26	Nagaon	-	Fruits & Vegetables (Pickle enterprises)	Fruits & Vegetables (Pickle enterprises)
Assam	27	Nalbari	Paddy	Rice products	Paddy
Assam	28	Sivasagar	-	Red Rice products	Red Rice
Assam	29	Sonitpur	Litchi	Jackfruit	Jackfruit
Assam	30	South Salmara	-	Cashew Nut processing	Cashew Nut
Assam	31	Tinsukia	-	Lemon	Lemon
Assam	32	Udalguri	Turmeric	Potato	Potato
Assam	33	West Karbi Anglong	-	Ginger	Ginger
Bihar	34	Araria	Groundnut	Makhana (Fox nut)	Makhana (Fox nut)
Bihar	35	Arawal	Paddy	Mango	Mango
Bihar	36	Aurangabad	Betel Vine	Strawberry	Strawberry
Bihar	37	Banka	Rice	Katarni Rice	Katarni Rice
Bihar	38	Begusarai	-	Chilly	Chilly
Bihar	39	Bhagalpur	Rice	Jardalu Mango	Jardalu Mango
Bihar	40	Bhojpur	Pea	Pea	Pea
Bihar	41	Buxer	-	Mentha	Mentha
Bihar	42	Darbhanga	Makhana	Makhana	Makhana
Bihar	43	East Champaran	Litchi and Honey	Litchi	Litchi
Bihar	44	Gaya	Mushroom & Honey	Mushroom	Mushroom
Bihar	45	Gopalganj	Papaya	Papaya	Papaya
Bihar	46	Jamui	Ber	Jack Fruit	Jack Fruit
Bihar	47	Jehanabad	-	Mushroom	Mushroom
Bihar	48	Kaimur	Guava	Guava	Guava
Bihar	49	Katihar	Makhana	Makhana (Foxnut)	Makhana
Bihar	50	Khagaria	-	Banana	Banana
Bihar	51	Kishanganj	Pineapple	Pineapple	Pineapple
Bihar	52	Lakhisarai	-	Tomato	Tomato
Bihar	53	Madhepura	Cucurbits	Mango	Mango
Bihar	54	Madhubani	Makhana	Makhana	Makhana
Bihar	55	Munger	Rice	Lemon Grass (Aromatic Plant)	Lemon Grass (Aromatic Plant)

Bihar	56	Muzaffarpur	Litchi and Honey	Litchi	Litchi
Bihar	57	Nalanda	Betel Vine	Potato	Potato
Bihar	58	Nawada	Betel Vine	Betel Vine	Betel Vine
Bihar	59	Patna	-	Onion	Onion
Bihar	60	Purnea	Makhana	Banana	Banana
Bihar	61	Rohtas	Tomato	Tomato	Tomato
Bihar	62	Saharsa	Makhana	Makhana	Makhana
Bihar	63	Samastipur	Turmeric & Honey	Turmeric	Turmeric
Bihar	64	Saran	Mushroom	Tomato	Tomato
Bihar	65	Sheikhpura	Onion	Onion	Onion
Bihar	66	Sheohar	Litchi and Honey	Moringa	Moringa
Bihar	67	Sitamadi	Litchi and Honey	Litchi	Litchi
Bihar	68	Siwan	Litchi and Honey	Mentha	Mentha
Bihar	69	Supaul	Makhana	Makhana	Makhana
Bihar	70	Vaishali	Banana/Honey	Honey	Honey
Bihar	71	West Champaran	Litchi and Honey	Sugarcane Products	Sugarcane
Chandigarh	1	Chandigarh	-	Bakery Product	Bakery Product
Chhattisgarh	2	Balod	-	Ginger Processing	Ginger
Chhattisgarh	3	Baloda bazar – Bhatapara	-	Poha	Paddy
Chhattisgarh	4	Balrampur	-	Sal Seeds	Groundnut
Chhattisgarh	5	Bemetara	Mustard	Papaya and tomato processing	Papaya
Chhattisgarh	6	Bijapur	-	Mahua Processing	Mahua
Chhattisgarh	7	Bilaspur	Others	Other	Others
Chhattisgarh	8	Dantewada (South Bastar)	Jackfruit	Mango	Mango
Chhattisgarh	9	Dhamtari	Lathyrus (Khesari)	Poha	Paddy
Chhattisgarh	10	Durg	-	Tomato based Products	Tomato
Chhattisgarh	11	Gariyaband	-	Chiraunjee	Chiraunjee
Chhattisgarh	12	Gaurela-Pendra Marwahi	Garlic	Custard Apple	Custard Apple
Chhattisgarh	13	Jagdarpur (Bastar)	-	Tamarind	Tamarind
Chhattisgarh	14	Janjgir-Champa	-	Rice based snack products	Paddy
Chhattisgarh	15	Jashpur	Cashewnut	Tea	Tea
Chhattisgarh	16	Kabirdham (Kawardha)	Guava	Jaggery	Sugarcane
Chhattisgarh	17	Kanker (North Bastar)	-	Custard Apple (Icecream, Pulp, Shake) Products	Custard Apple
Chhattisgarh	18	Kondagaon	-	Cashew Products	Cashew nut
Chhattisgarh	19	Korba	-	Mahua	Mahua Processing

				Processing	
Chhattisgarh	20	Koria	Tuberose	Litchi	Tomato
Chhattisgarh	21	Mahasamund	-	Milk based products (Milk Powder)	Milk based products (Milk Powder)
Chhattisgarh	22	Mungeli	Lathyrus	Tomato Processing	Tomato
Chhattisgarh	23	Narayanpur	Custard Apple	Harra Processing	Harra
Chhattisgarh	24	Raigarh	Cucurbits (Bottle gourd, Musk Melon, Bitter gourd)	Banana	Banana
Chhattisgarh	25	Raipur	-	Jam, Jelly (Papaya)	Papaya
Chhattisgarh	26	Rajnandgaon	-	Poha	Paddy
Chhattisgarh	27	Sukma	Brinjal	Jowar, Kodo – Kutki based products	Millets
Chhattisgarh	28	Surajpur	Marigold	Turmeric based products	Turmeric
Chhattisgarh	29	Surguja	Scented Rice	Litchi Products (Squashes, Juices)	Litchi
Dadra and Nagar Haveli and Daman and Diu	1	Dadar and Nagar Haveli	-	Mango and Allied Products	Mango
Dadra and Nagar Haveli and Daman and Diu	2	Daman	-	Other	Others
Dadra and Nagar Haveli and Daman and Diu	3	Diu	-	Other	Others
Delhi	1	Central Delhi	-	Marketing Unit	Marketing Unit
Delhi	2	East Delhi	-	Marketing Unit	Marketing Unit
Delhi	3	New Delhi	-	Marketing Unit	Marketing Unit
Delhi	4	North Delhi	-	Marketing Unit	Marketing Unit
Delhi	5	North East Delhi	-	Marketing Unit	Marketing Unit
Delhi	6	North West Delhi	-	Marketing Unit	Marketing Unit
Delhi	7	Shahdara	-	Marketing Unit	Marketing Unit
Delhi	8	South Delhi	-	Marketing Unit	Marketing Unit
Delhi	9	South East Delhi	-	Marketing Unit	Marketing Unit
Delhi	10	South-West	Cauliflowe r	Marketing Unit	Marketing Unit
Delhi	11	West Delhi	Carrot	Marketing Unit	Marketing Unit

Goa	1	North Goa	Mango	JackFruit	JackFruit
Goa	2	South Goa	Cashewnut	Coconut	Coconut
Gujarat	1	Ahmedabad	Wheat	Wheat based products	Wheat
Gujarat	2	Amreli	Mango	Groundnut based products	Mango
Gujarat	3	Anand	Banana	Banana based products	Banana
Gujarat	4	Arvalli	Potato	Potato based products	Potato
Gujarat	5	Banaskantha	Potato	Pomegranate based products	Pomegranate
Gujarat	6	Bharuch*	Banana	Banana based products	Banana
Gujarat	7	Bhavnagar	Onion	Onion based products	Onion
Gujarat	8	Botad	Guava	Guava based products	Guava
Gujarat	9	Chhota Udaipur	-	Maize based products	Maize
Gujarat	10	Dahod	-	Soybean based products	Soybean
Gujarat	11	Dang	Finger Millets (Ragi)	Finger Millet based products	Finger Millet (Ragi/Mandua)
Gujarat	12	Devbhoomi Dwarka	-	Groundnut based products	Groundnut
Gujarat	13	Gandhinagar	Potato	Vegetable-Okra based products	Okra
Gujarat	14	Gir Somnath	Mango	Mango based	Mango
Gujarat	15	Jamnagar	-	Groundnut based products	Groundnut
Gujarat	16	Junagadh	Mango	Coriander based products	Coriander
Gujarat	17	Kheda	-	Datepalm based products	Datepalm
Gujarat	18	Kutch	Datepalm	Rice based products	Paddy
Gujarat	19	Mahisagar	Papaya	Papaya based products	Papaya
Gujarat	20	Mehsana*	Fennel (KVK)	Cumin based products	Cumin
Gujarat	21	Morbi	Sesamum	Sesamum based products	Sesamum
Gujarat	22	Narmada*	Banana	Banana based products	Banana
Gujarat	23	Navsari	Mango	Mango based products	Mango
Gujarat	24	Panchamahhal	Maize	Maize based products	Maize



Gujarat	25	Patan	Cumin	Cumin based products	Cumin
Gujarat	26	Porbandar	-	Gram based products	Gram
Gujarat	27	Rajkot	-	Groundnut based products	Groundnut
Gujarat	28	Sabarkantha*	Potato	Vegetable Cauliflower, Cabbage based products	Vegetables
Gujarat	29	Surat*	Banana	Banana based products	Banana
Gujarat	30	Surendranagar	Cumin	Cumin based products	Cumin
Gujarat	31	Tapi	Sorghum	Sorghum based products	Sorghum
Gujarat	32	Vadodara	-	Tur based products	Tur
Gujarat	33	Valsad	Mango	Sapota based products	Sapota
Haryana	1	Ambala	Potato	Onion	Onion
Haryana	2	Bhiwani	Strawberry	Citrus Fruits	Citrus Fruits
Haryana	3	Ch. dadri	Tomato	Cucurbits	Cucurbits
Haryana	4	Faridabad	Cauliflower	Cucurbits	Cucurbits
Haryana	5	Fatehabad	Guava	Citrus Fruits	Citrus Fruits
Haryana	6	Gurugram	Agri And	Amla	Amla
Haryana	7	Hisar	Strawberry	Milk & Milk products	Milk & Milk products
Haryana	8	Jhajjar	Carrot	Guava	Guava
Haryana	9	Jind	Mushroom	Poultry Meat	Poultry
Haryana	10	Kaithal	Basmati Rice	Milk & Milk Products	Milk & Milk Products
Haryana	11	Karnal	-	Leafy Vegetables	Leafy Vegetables
Haryana	12	Kurukshetra	Potato	Potato	Potato
Haryana	13	Mahendergarh/ Narnaul	Bajra	Citrus	Citrus
Haryana	14	Mewat/Nuh	Castor	Tomato	Tomato
Haryana	15	Palwal	Gourds	Radish	Tomato
Haryana	16	Panchkula	Ginger	Poultry	Ginger
Haryana	17	Panipat	Peas	Carrot	Carrot
Haryana	18	Rewari	-	Mustard	Mustard
Haryana	19	Rohtak	Gourds	Cucumber	Cucurbits
Haryana	20	Sonepat	Sweet & Baby Corn	Peas	Peas
Haryana	21	Sirsa	Kinnow	Citrus(Kinnow)	Kinnow
Haryana	22	Y. Nagar	Mango	Mango	Mango
Himachal Pradesh	1	Bilaspur	-	Turmeric	Turmeric
Himachal Pradesh	2	Chamba	Rajma	Apple	Apple
Himachal Pradesh	3	Hamirpur	-	Milk and Dairy products	Milk and Dairy products
Himachal Pradesh	4	Kangra	Honey/ Tea	Mango	Mango

Himachal Pradesh	5	Kinnaur	Green peas	Fruit Wine	Fruit Wine
Himachal Pradesh	6	Kullu	Garlic	Apple	Apple
Himachal Pradesh	7	Lahaul & Spiti	-	Sea buckthorn	Sea buckthorn
Himachal Pradesh	8	Mandi	-	Peas and Vegetables	Peas and Vegetables
Himachal Pradesh	9	Shimla	Apple	Apple	Apple
Himachal Pradesh	10	Sirmour	Dry Ginger	Ginger and Garlic	Ginger and Garlic
Himachal Pradesh	11	Solan	Mushroom	Mushroom	Mushroom
Himachal Pradesh	12	Una	-	Potato	Potato
Jharkhand	1	Bokaro	Cauliflower	Jack fruit	
Jharkhand	2	Chatra	Wood apple (Bael)	Tomato	
Jharkhand	3	Deogarh	Jackfruit	Peda	
Jharkhand	4	Dhanbad	Brinjal	Potato	
Jharkhand	5	Dumka	Bitter Gourd	Peda	
Jharkhand	6	E Singhbhum	Cashew nut	Tomato	
Jharkhand	7	Garhwa	Small mirchi	Potato	
Jharkhand	8	Giridih	Okra	Tomato	
Jharkhand	9	Godda	Okra	Mango	
Jharkhand	10	Gumla	Tomato	Green Chili	
Jharkhand	11	Hazaribagh	Coriander	Jaggery	
Jharkhand	12	Jamtara	Cashew	Green Chili	
Jharkhand	13	Khunti	Jackfruit & Lac	Tamarind	
Jharkhand	14	Koderma	-	Lime	Lime
Jharkhand	15	Latehar	Mahua	Mahua	Mahua
Jharkhand	16	Lohardagga	Garden pea	Honey	
Jharkhand	17	Pakud	Mango	Mango	Mango
Jharkhand	18	Palamu	Okra	Tomato	
Jharkhand	19	Ramgarh	French Beans	Papaya	
Jharkhand	20	Ranchi	Paddy	Guava	
Jharkhand	21	Sahibganj	Mango	Mango	Mango
Jharkhand	22	Saraikela Kharsawan	Chironji	Chironji	Chironji
Jharkhand	23	Simdega	Papaya/Lac	Mango	
Jharkhand	24	W Singhbhum	Custard apple	Custard Apple	Custard apple
Jammu & Kashmir	1	Ananthnag	Walnut	Other	Others
Jammu & Kashmir	2	Bandipora	--	Other	Others
Jammu & Kashmir	3	Baramulla*	Apple	Apple based industries	Apple
Jammu & Kashmir	4	Budgam	Pear (Nakh)	Dairy product	Dairy product
Jammu & Kashmir	5	Doda	--	Spices	Olive
Jammu & Kashmir	6	Ganderbal	--	Other	Others
Jammu & Kashmir	7	Jammu	--	Dairy Products	Dairy Products
Jammu & Kashmir	8	Kathua	--	Spices	Spices (to be specified)
Jammu & Kashmir	9	Kishtwar	--	Walnut processing	Walnut
Jammu & Kashmir	10	Kulgam	--	Spices & pickle	Spices & pickle (to be specified)
Jammu & Kashmir	11	Kupwara	Walnut	Walnut processing	Walnut

Jammu & Kashmir	12	Poonch	--	Millet based product	Millets
Jammu & Kashmir	13	Pulwama	Saffron	Saffron	Saffron
Jammu & Kashmir	14	Rajouri	--	Dairy Product	Dairy Product
Jammu & Kashmir	15	Ramban	--	Honey	Honey
Jammu & Kashmir	16	Reasi	--	Spices	Spices
Jammu & Kashmir	17	Sambha	--	Mushroom industries	Mushroom industries
Jammu & Kashmir	18	Shopion*	Apple	Apple based industries	Apple
Jammu & Kashmir	19	Srinagar	Plum/Honey	Packed bakery products	Packed bakery products
Jammu & Kashmir	20	Udhampur	--	Pickles	Pickles
Karnataka	1	Bagalkot	Grapes	Onion	Onion
Karnataka	2	Ballari	Onion	Fig	Fig
Karnataka	3	Belagavi (Belgaum)*	Vegetables (Cauliflower, Cabbage, Beetroot, Chilli, Tomato, Cucumber etc)	Jaggery	Sugarcane
Karnataka	4	Bengaluru (Rural)	Grapes	Other	Others
Karnataka	5	Bengaluru (Urban)	Pomello	Bakery products	Bakery products
Karnataka	6	Bidar	Ginger	Ginger	Ginger
Karnataka	7	Chamarajanagar	Tumeric	Turmeric	Tumeric
Karnataka	8	Chikaballapur	Rose onion	Tomato	Tomato
Karnataka	9	Chikkamagaluru	Pepper	Spices	Spices (Pepper)
Karnataka	10	Chitradurga	Pomegranate	Groundnut products	Groundnut
Karnataka	11	Dakshina kannada	Cashew	Other	Others
Karnataka	12	Davanagere	Rice	Millets	Millets
Karnataka	13	Dharwad	-	Red Chilli	Mango
Karnataka	14	Gadag	-	Byadagi Chillies	Byadagi Chillies
Karnataka	15	Hassan	-	Coconut products	Coconut
Karnataka	16	Haveri	Chilli	Mango	Mango
Karnataka	17	Kalaburgi	Redgram	Redgram	Redgram
Karnataka	18	Kodagu/Coorg	Coorg Orange/Honey	Coffee	Coffee
Karnataka	19	Kolar	Mango	Tomato	Tomato
Karnataka	20	Koppal	Rice	Guava	Guava
Karnataka	21	Mandya	Ragi	Jaggery (Sugarcane)	Sugarcane
Karnataka	22	Mysuru	Banana	Banana	Banana
Karnataka	23	Raichur	Rice	Chillies	Chilli
Karnataka	24	Ramanagar	Mango	Coconut	Coconut
Karnataka	25	Shivamogga	Pineapple	Pineapple	Pineapple
Karnataka	26	Sirsi	Honey	-	Honey
Karnataka	27	Tumakuru	Coconut	Coconut	Coconut
Karnataka	28	Udupi	Mallige flower	Marine products	Marine products
Karnataka	29	Uttara Kannada	Cocoa	Spices	Spices

Karnataka	30	Vijayapura	Jowar	Lime/Lemon	Lime/Lemon
Karnataka	31	Yadgiri	Bajra	Groundnut products	Groundnut
Kerala	1	Alappuzha*	Turmeric	Rice Products	Paddy
Kerala	2	Ernakulam	Pineapple	Pineapple	Pineapple
Kerala	3	Idukki*	Cardamom	Spices	Cardamom
Kerala	4	Kannur	Mango	Coconut Oil	Coconut
Kerala	5	Kasargod	-	Mussels	Mussels
Kerala	6	Kollam	Tuber	Tapioca and Tuber crop products	Tubers
Kerala	7	Kottayam	Pineapple	Coconut oil and coconut powder	Pineapple
Kerala	8	Kozhikkode	Coconut	Coconut products	Coconut
Kerala	9	Malappuram	Betel vine	Coconut products	Coconut
Kerala	10	Palakkad	Rice	Banana	Banana
Kerala	11	Pathananthitta	Jackfruit	Banana	Jackfruit
Kerala	12	Thrissur*	Banana	Rice	Paddy
Kerala	13	Trivandrum*	Banana	Tapioca	Tapioca
Kerala	14	Wayanad	-	Milk and milk products	Milk and milk products
Ladakh	1	Kargil	Apricot	Apricot	Apricot
Ladakh	2	Leh	Apple	Sea buckthorn	Sea buckthorn
Lakshadweep	1	Lakshadweep	Coconut	Coconut	Coconut
Madhya Pradesh	1	Agar Malwa	Mandarin	Orange/Citrus	Mandarin/ Orange/Citrus
Madhya Pradesh	2	Alirajpur	Custard Apple	Custard Apple	Custard Apple
Madhya Pradesh	3	Anuppur	Kodo Millet	Mango	Mango
Madhya Pradesh	4	Ashoknagar	-	Tomato	Tomato
Madhya Pradesh	5	Balaghat	-	Kodo Kutki	Small Millets
Madhya Pradesh	6	Barwani	Papaya	Ginger	Ginger
Madhya Pradesh	7	Betul	-	Mango	Mango
Madhya Pradesh	8	Bhind	-	Bajra	Bajra
Madhya Pradesh	9	Bhopal	Soybean	Guava	Guava
Madhya Pradesh	10	Burhanpur	Banana	Banana	Banana
Madhya Pradesh	11	Chhatarpur	Blackgram	Betel vine	Betel vine
Madhya Pradesh	12	Chhindwara	Orange (Mandrin)	Potato	Potato
Madhya Pradesh	13	Damoh(Apeda for Onion)	Gram	Tomato	Tomato
Madhya Pradesh	14	Datia	-	Tomato	Tomato
Madhya Pradesh	15	Dewas	Durum wheat	Potato	Potato
Madhya Pradesh	16	Dhar	Bread Wheat	Custard Apple	Custard Apple
Madhya Pradesh	17	Dindori	Kodo- Kutki	Kodo-Kutki	Small Millets
Madhya Pradesh	18	Guna	-	Coriander	Coriander
Madhya Pradesh	19	Gwalior*	Bread Wheat	Potato	Bread Wheat
Madhya Pradesh	20	Harda	-	Onion	Onion
Madhya Pradesh	21	Hoshangabad	-	Guava	Guava
Madhya Pradesh	22	Indore(Apeda for	Wheat	Potato	Potato

		Onion)			
Madhya Pradesh	23	Jabalpur	Vegetable pea	Green Pea	Green Pea
Madhya Pradesh	24	Jhabua	Bread Wheat	Tomato	Tomato
Madhya Pradesh	25	Katni	-	Tomato	Tomato
Madhya Pradesh	26	Khandwa(Ape da for Pomegranate)	Colocasia	Onion	Onion
Madhya Pradesh	27	Khargone(Ape da for Pomegranate)	Wheat	Green Chili	Green Chili
Madhya Pradesh	28	Mandla	Kodo & Kutki	Kodo & Kutki	Small millets
Madhya Pradesh	29	Mandsaur	Bread wheat	Garlic	Garlic
Madhya Pradesh	30	Morena	Mustard & Honey	Mustard	Mustard & Honey
Madhya Pradesh	31	Narsinghpur	-	Other	Others
Madhya Pradesh	32	Neemuch	Coriander	Coriander	Coriander
Madhya Pradesh	33	Niwari	-	Ginger	Ginger
Madhya Pradesh	34	Panna	-	Aonla	Aonla
Madhya Pradesh	35	Raisen	Bread Wheat		Tomato
Madhya Pradesh	36	Rajgarh	Bread Wheat	Orange/Citrus	Orange/Citrus
Madhya Pradesh	37	Ratlam	Bread Wheat	Garlic	Garlic
Madhya Pradesh	38	Rewa	Taramira	Turmeric	Turmeric
Madhya Pradesh	39	Sagar(Apeda for Onion)	Chickpea	Tomato	Tomato
Madhya Pradesh	40	Satna	-	Tomato	Tomato
Madhya Pradesh	41	Sehore	Wheat	Guava	Bread wheat
Madhya Pradesh	42	Seoni	Custard Apple	Custard Apple	Custard Apple
Madhya Pradesh	43	Shahdol	-	Turmeric	Turmeric
Madhya Pradesh	44	Shajapur	Bread Wheat		Onion
Madhya Pradesh	45	Sheopur	Guava	Guava	Guava
Madhya Pradesh	46	Shivpuri	-	Tomato	Tomato
Madhya Pradesh	47	Sidhi	-	Mango	Mango
Madhya Pradesh	48	Singrauli	-	Mango	Mango
Madhya Pradesh	49	Tikamgarh	-	Ginger	Ginger
Madhya Pradesh	50	Ujjain	Durum wheat	Onion	Onion
Madhya Pradesh	51	Umari	-	Mango	Mango
Madhya Pradesh	52	Vidisha	Bread Wheat		Onion
Maharashtra	1	Ahmednagar*	Pomegranate	Milk based product	
Maharashtra	2	Akola	-	Gram based products	Gram based products
Maharashtra	3	Amravati*	Mandrin Orange	Mandrin Orange	Mandrin Orange
Maharashtra	4	Aurangabad	Sweet Orange	Maize based products	
Maharashtra	5	Beed	Custard Apple	Custard Apple	Custard Apple
Maharashtra	6	Bhandara	Rice	Rice based products (Poha, Murmure etc.)	Rice
Maharashtra	7	Buldhana	-	Custard Apple	Custard Apple
Maharashtra	8	Chandrapur	-	Rice based products	Rice

				(Poha, Murmure etc.)	
Maharashtra	9	Dhule	Bajra	Banana	
Maharashtra	10	Gadchiroli	-	Minor Forest Produce (Mahua/ Honey/ Hirda/ Behda etc.)	Minor Forest Produce (Mahua/ Honey/ Hirda/ Behda etc.)
Maharashtra	11	Gondia	-	Rice Based Products ( Poha, Murmura etc. )	Rice
Maharashtra	12	Hingoli	Turmeric	Spice based products (Turmeric etc.)	Turmeric
Maharashtra	13	Jalgaon*	Banana	Banana	Banana
Maharashtra	14	Jalna	Sweet Orange	Sweet Orange	Sweet Orange
Maharashtra	15	Kolhapur	Rice	Sugarcane products (Jaggery) etc.	
Maharashtra	16	Latur	-	Tomato	
Maharashtra	17	Mumbai	-	Other	Others
Maharashtra	18	Mumbai Suburban		Other	Others
Maharashtra	19	Nagpur*	Mandrin Orange	Mandrin Orange	Mandrin Orange
Maharashtra	20	Nanded	-	Spice based products (Turmeric, Chilly)	
Maharashtra	21	Nandurbar	Pigeonpea	Millet based products (Hill Millet, Finger Millet etc.- Flour/ Papad/ Satva)	
Maharashtra	22	Nasik	Onion	Onion	Onion
Maharashtra	23	Osmanabad	-	Gram based product	Gram based product
Maharashtra	24	Palghar	Sapota	Sapota	Sapota
Maharashtra	25	Prabhani	-	Jaggery	Jaggery
Maharashtra	26	Pune	Rice	Tomato	
Maharashtra	27	Raigad	-	Other	Others
Maharashtra	28	Ratnagiri	Mango	Mango	Mango
Maharashtra	29	Sangli*	Grapes	Grapes	Grapes
Maharashtra	30	Satara	Strawberry	Sugarcane based product (Jaggery) etc.	
Maharashtra	31	Sindhudurg	Mango	Mango	Mango
Maharashtra	32	Solapur	Sorghum	Millet based products (Jowar, Wheat-Flour/ Biscuits etc.)	

Maharashtra	33	Thane	-	Millet based products	Millet based products
Maharashtra	34	Wardha*	Orange	Spices (turmeric)	
Maharashtra	35	Wasim	-	Gram based products	Gram based products
Maharashtra	36	Yavatmal	-	Spices based product	Spices based product
Manipur	1	Bishnupur	Black Aromatic Rice	Other	Others
Manipur	2	Chandel	Turmeric	Ginger	Ginger
Manipur	3	Churachandpur	Ginger	Pineapple	Pineapple
Manipur	4	Imphal East	Pineapple	Pineapple	Pineapple
Manipur	5	Imphal West	Black Aromatic Rice	Other	Others
Manipur	6	Jiribam	--	Coconut	Coconut
Manipur	7	Kakching	Ginger	Black Aromatic Rice	Black Aromatic Rice
Manipur	8	Kamjong	King Chilli	King Chilli	King Chilli
Manipur	9	Kangpokpi	--	Turmeric	Turmeric
Manipur	10	Noney	--	Banana	Banana
Manipur	11	Pherzawl	Ginger	Ginger	Ginger
Manipur	12	Senapati	Turmeric	Kiwi	Kiwi
Manipur	13	Tamenglong	Tamenglong Orange	Orange	Orange
Manipur	14	Tengnoupal	Ginger	Bamboo shoot	Bamboo
Manipur	15	Thoubal	Black Aromatic Rice	Pineapple	Pineapple
Manipur	16	Ukhrul	Kachai Lemon	Kachai Lemon	Kachai Lemon
Meghalaya	1	East Garo Hills	Pine Apple	Pineapple	Pineapple
Meghalaya	2	East Khasi Hills	Mandarin	Sohiong	Sohiong
Meghalaya	3	East Jantia Hills	-	Turmeric	Turmeric
Meghalaya	4	North Garo hills	Banana	Banana	Banana
Meghalaya	5	Ri Bhoi	Strawberry	Pineapple	Pineapple
Meghalaya	6	Shillong (West Khasi Hills)	Chow chow	Ginger	Ginger
Meghalaya	7	South Garo Hills	Cashewnut	Jackfruit	Jackfruit
Meghalaya	8	South West Garo Hill	Pineapple	Pineapple	Pineapple
Meghalaya	9	West Garo hills	Cashewnut	Cashewnut	Cashewnut
Meghalaya	10	West Jaintia Hills*	Turmeric	Turmeric	Turmeric
Meghalaya	11	South West Khasi Hills	Chow chow	Honey	Honey
Mizoram	1	Aizawl	Dragon Fruit	Ginger	Mizo chilli
Mizoram	2	Champhai	Banana	Ginger	Passion Fruit
Mizoram	3	Hnahthial	Turmeric	Turmeric	Turmeric
Mizoram	4	Khawzawl	Mizo chilli	Pineapple	Pineapple
Mizoram	5	Kolasib	Mizo chilli	Ginger	Turmeric
Mizoram	6	Lawngtlai	Ginger	Turmeric	Mango
Mizoram	7	Lunglei	Cabbage	Turmeric	Turmeric
Mizoram	8	Mamit	-	Turmeric	Turmeric
Mizoram	9	Saitual	Mizo chilli	Ginger	Ginger
Mizoram	10	Serchhip	Dragon fruit	Pineapple	Pineapple
Mizoram	11	Siaha	Mizo Chilli	Turmeric	Turmeric
Nagaland	1	Dimapur	Pineapple	Pineapple	Pineapple

				products	
Nagaland	2	Kiphire	Large Cardamom	Rajma products	Rajma
Nagaland	3	Kohima	Rice	Pickle products	Pickle (Specify)
Nagaland	4	Longleng	Passion Fruit	Ginger products	Ginger
Nagaland	5	Mokokchung	Arecanut	Coffee products	Coffee
Nagaland	6	Mon	Naga Mirch	Large Cardamom products	Large Cardamom
Nagaland	7	Peren	Ginger	Naga King Chili products	Naga King Chili
Nagaland	8	Phek	Kiwi	Kiwi products	kiwi
Nagaland	9	Tuensang	Kiwi	Rajma Products	Rajma
Nagaland	10	Wokha	Passion fruit	Other	Others
Nagaland	11	Zunheboto	Large Cardamom	Soybean products	Soybean
Odisha	1	Angul	-	Fruit Based Products (Mango)	Mango
Odisha	2	Balasore	-	Other	Others
Odisha	3	Bargarh	-	Oilseed based Products (Groundnut)	Groundnut
Odisha	4	Bhadrak	-	Other	Others
Odisha	5	Bolangir	-	Milk based product	Milk based product
Odisha	6	Boudh	-	Dal processing	Pulses
Odisha	7	Cuttack	Local betel vine	Milk based product	Milk based product
Odisha	8	Deogarh	-	Tamarind based products	Tamarind
Odisha	9	Dhenkanal	-	Milk based products	Milk based products
Odisha	10	Gajapati	-	Fruit based product (pineapple)	Pineapple
Odisha	11	Ganjam	Kewda flower	Other	Others
Odisha	12	Jagatsinghpur	-	Milk based product	Milk based product
Odisha	13	Jajpur	-	Oilseed based Products (Groundnut)	Groundnut
Odisha	14	Jharsuguda	-	Spices based Products (Chilli)	Chilli
Odisha	15	Kalahandi	Foxtail millet	Other	Others
Odisha	16	Kandhamal	Turmeric	Spices based Products (Turmeric)	Turmeric
Odisha	17	Kendrapara	-	Milk based Products	Milk based Products



Odisha	18	Kendujhar	Tomato	Urad based products	Urad
Odisha	19	Khordha	Mushroom	Other	Others
Odisha	20	Koraput	Finger millet	Spices based Products (Ginger)	Ginger
Odisha	21	Malkangiri	-	Millet based product	Millets
Odisha	22	Mayurbhanj	-	Honey based products	Honey
Odisha	23	Nabaranganpur	-	Maize based Products	Maize
Odisha	24	Nayagarh	Brinjal	Sugarcane based products	Sugarcane
Odisha	25	Nuapada	-	Millet based Products	Millets
Odisha	26	Puri	-	Milk based Products	Milk based Products
Odisha	27	Rayagada	-	Tamarind based Products	Tamarind
Odisha	28	Sambalpur	Bambra Chilli	Spices based products (Chilli)	Chilli
Odisha	29	Subarnapur	-	Fruit based product (Mango)	Mango
Odisha	30	Sundargarh	Litchi	Mushroom processing	Mushroom
Puducherry	1	Karaikal	Pulses	Other	Others
Puducherry	2	Puducherry	Nutri Cereals	Milk based product	Milk based product
Punjab	1	Amritsar	Peas	Pickle and Murabba	Pickle and Murabba (Specify)
Punjab	2	Barnala	-	Milk & Milk Products	Milk & Milk Products
Punjab	3	Bathinda	Kinnow/H on ey	Honey	Honey
Punjab	4	Fatehgarh Sahib	-	Jaggery	Sugarcane
Punjab	5	Faridkot	-	Other	Others
Punjab	6	Fazilka	Kinnow	Kinnow	Kinnow
Punjab	7	Ferozpur	-	Chillies	Chillies
Punjab	8	Gurdaspur	-	Cauliflower and allied products	Cauliflower and allied products
Punjab	9	Hoshiarpur*	Potato	Jaggery and allied products	Sugarcane
Punjab	10	Jalandhar*	Potato	Potato	Potato
Punjab	11	Kapurthala*	Potato	Tomato	Tomato
Punjab	12	Ludhiana	Guava	Bakery products	Bakery products
Punjab	13	Mansa	-	Milk and milk product	Milk and milk product
Punjab	14	Moga	-	Potato	Potato
Punjab	15	Nawashahar*	Potato	-	Potato

Punjab	16	Pathankot	-	Litchi	Litchi
Punjab	17	Patiala	Peas	Guava	Guava
Punjab	18	Roopnagar	-	Mango	Mango
Punjab	19	Sangrur	-	Onion	Onion
Punjab	20	SAS Nagar	Guava	Milk and milk products	Milk and milk products
Punjab	21	SBS Nagar	-	Peas	Peas
Punjab	22	Sri Muktsar Sahib	Kinnow	Milk and milk products	Milk and milk products
Punjab	23	Tarntaran	Pear	Pear	Pear
Rajasthan	1	Ajmer	-	Rose	Rose
Rajasthan	2	Alwar	Rapeseed & Mustard	Onion	Onion
Rajasthan	3	Banswara	-	Mango	Mango
Rajasthan	4	Baran	Garlic	Garlic	Garlic
Rajasthan	5	Barmer	Bajra	Pomegranate	Bajra
Rajasthan	6	Bharatpur	Rape & Mustard/Honey	Rape & Mustard	Rape & Mustard/Honey
Rajasthan	7	Bhilwara	-	Maize based products	Maize
Rajasthan	8	Bikaner	Groundnut	Moth	Moth
Rajasthan	9	Bundi	-	Rice based	Paddy
Rajasthan	10	Chittor	-	Jaggery	Sugarcane
Rajasthan	11	Churu	Moth	Groundnut Products	Groundnut
Rajasthan	12	Dausa	-	Wheat (Cereal based Products Barley, Bajra, Dalia, Tomato etc.)	SINGLE PRODUCT TO BE SPECIFIED
Rajasthan	13	Dholpur	Rapeseed & Mustard	Potato Based Products	Potato
Rajasthan	14	Dungarpur	Urad	Mango	Mango
Rajasthan	15	Ganganagar	Kinnow	Kinnow	Kinnow
Rajasthan	16	Hanumangarh	-	Wheat based products	Wheat
Rajasthan	17	Jaipur	Tomato	Tomato	Tomato
Rajasthan	18	Jaisalmer	Bajra	Xerophytic Fruits	Xerophytic Fruits
Rajasthan	19	Jhalawar	Orange	Orange	Orange
Rajasthan	20	Jalore*	Cumin	Isabgol	Isabgol
Rajasthan	21	Jhunjhunu	Gram	Lemon	Lemon
Rajasthan	22	Jodhpur	Cumin	Cumin	Cumin
Rajasthan	23	Karauli	Sesame	Sesame	Sesame
Rajasthan	24	Kota	Coriander/Honey	Coriander	Coriander
Rajasthan	25	Nagaur	Cumin	Fenugreek	Fenugreek
Rajasthan	26	Pali*	Cumin	Milk based Products	Milk based Products
Rajasthan	27	Pratapgarh	-	Garlic	Garlic
Rajasthan	28	Rajsamand	-	Fruit based product	Fruit based product (to be specified)
Rajasthan	29	S.Madhampur	Guava	Guava	Guava
Rajasthan	30	Sikar	Onion	Onion	Onion

Rajasthan	31	Sirohi	Fennel (Sonf)	Fennel	Fennel
Rajasthan	32	Tonk	Urad	Rape & Mustard	Rapeseed& Mustard
Rajasthan	33	Udaipur	-	Forest based products	Forest Based Products
Sikkim	1	East Sikkim	Turmeric	Red Cherry Pepper (Dalley Khorsani)	Redcherry Pepper
Sikkim	2	North Sikkim	Large Cardamom	Large Cardamom	Large Cardamom
Sikkim	3	South Sikkim	Ginger	Ginger	Ginger
Sikkim	4	West Sikkim	Large cardamom	Minimally processed Vegetable	Minimally processed Vegetables
Tamil Nadu	1	Ariyalur	Cashew	Cashew processing	Cashew nut
Tamil Nadu	2	Chengalpattu	Paddy	Other	Others
Tamil Nadu	3	Coimbatore	Curry leaves	Coconut product	Coconut
Tamil Nadu	4	Cuddalore	Cashew	Cashew processing	Cashew nut
Tamil Nadu	5	Dharmapuri	Sorghum	Millet products (except maize)	Millets
Tamil Nadu	6	Dindigul	Banana	Animal feed	Animal feed
Tamil Nadu	7	Erode	Turmeric	Turmeric based Units	Turmeric
Tamil Nadu	8	Kallakurichi	-	Edible oils	Groundnut
Tamil Nadu	9	Kanchipuram	Brinjal	Edible oils	Groundnut
Tamil Nadu	10	Kanniyakumari	Banana	Other	Others
Tamil Nadu	11	Karur	Moringa	Moringa product	Moringa
Tamil Nadu	12	Krishnagiri	Mango	Mango product	Mango
Tamil Nadu	13	Madurai	Jasmine	Dhal products	Pulses
Tamil Nadu	14	Nagapattinam	-	Other	Others
Tamil Nadu	15	Namakkal	Groundnut	Poultry feeds and products	Poultry feeds and products
Tamil Nadu	16	Perambalur	-	Animal Feed	Animal Feed
Tamil Nadu	17	Pudukottai	Cashew	Cashew processing	Cashew nut
Tamil Nadu	18	Ramanathapuram	Chillies	Other	Others
Tamil Nadu	19	Ranipet	Paddy	Edible oils	Groundnut
Tamil Nadu	20	Salem	Turmeric	Tapioca products	Tapioca
Tamil Nadu	21	Sivagangai	Brinjal	Coconut products	Coconut
Tamil Nadu	22	Tenkasi	Acid lime	Pickles	Pickles (Acid lime)
Tamil Nadu	23	Thanjavur	Paddy	Coconut products	Coconut
Tamil Nadu	24	The Nilgiris	Carrot	Vegetable processing	Vegetables
Tamil Nadu	25	Theni*	Banana	Banana based	Banana

				products	
Tamil Nadu	26	Thiruvallur	Paddy	Dhal product	Pulses
Tamil Nadu	27	Thoothukudi	Blackgram	Palm products	Palm products
Tamil Nadu	28	Tiruchirapalli*	Banana	Banana	Banana
Tamil Nadu	29	Tirunelveli	Banana	Papad Units	Papad Units (to be specified)
Tamil Nadu	30	Tirupattur	Cotton	Dhal product	Pulses
Tamil Nadu	31	Tiruppur	Gloriosa superba	Poultry feed product	Poultry feed product
Tamil Nadu	32	Tiruvannamalai	Groundnut	Edible oils	Groundnut
Tamil Nadu	33	Tiruvarur	Paddy	Dhal product	Pulses
Tamil Nadu	34	Vellore	Brinjal	Dairy product	Dairy product
Tamil Nadu	35	Villupuram	Papaya	Edible oils	Groundnut
Tamil Nadu	36	Virudhunagar	Millet	Millet products (except maize)	Millets
Telangana	1	Adilabad	Soybean	Soybean based products	Soybean
Telangana	2	Bhadadri Kothagudem	--	chilli	Chilli
Telangana	3	Hyderabad	--	RTE Snacks	RTE Snacks
Telangana	4	Jagitial	-	Mango	Mango
Telangana	5	Jangaon	-	Scented Rice (Chittimuthyalu) based products	Scented Rice (Chittimuthyalu)
Telangana	6	Jayashankar Bhupally	-	Chilli	Chilli
Telangana	7	Jogulamba Gadwal	-	Groundnut based product	Groundnut
Telangana	8	Kamareddy	-	Soya based RTE, RTC, RTS products	Soybean
Telangana	9	Karimnagar*	Turmeric	Rice based product	Paddy
Telangana	10	Khammam*	Chilli	Chillies	Chilli
Telangana	11	Komaram Bheem	--	Millet based products	Millets
Telangana	12	Mahabubabad	Mango	Chillies	Chillies
Telangana	13	Mahabubnagar*	Mango	Millets	Millets
Telangana	14	Mancherial	-	Mango	Mango
Telangana	15	Madak	-	Other	Others
Telangana	16	Medchal Malkagiri	-	Other	Others
Telangana	17	Mulugu	-	Chillies	Chillies
Telangana	18	Nagarkurnool	Groundnut	Mango	Mango
Telangana	19	Nalgonda	sweet orange	Sweet Orange	sweet orange
Telangana	20	Narayanpet	Red gram	Groundnut based products	Groundnut
Telangana	21	Nirmal	-	Soybean based products	Soybean
Telangana	22	Nizamabad*	Turmeric	Turmeric	Turmeric
Telangana	23	Peddapalli	-	Rice based products	Paddy

Telangana	24	Rajanna Sircilla	-	Other	Others
Telangana	25	Rangareddy*	Mango	Vegetables	Vegetables
Telangana	26	Sangareddy	Ginger	Milk based products	Milk based products
Telangana	27	Siddipet	Green Chilies	Vegetables	Vegetables
Telangana	28	Suryapet	-	Milk based products	Milk based products
Telangana	29	Vikarabad	Red gram	Vegetables	Vegetables
Telangana	30	Wanaparthy	Groundnut	Groundnut	Groundnut
Telangana	31	Warangal Rural	Mango	Bamboo Chili	Bamboo Chili
Telangana	32	Warangal Urban	Mango	Other	Others
Telangana	33	Yadadri Bhuvanagiri	-	Milk based products	Milk based products
Tripura	1	Dhalai	Blackgram	Other	Others
Tripura	2	Gomati	Orange	Other	Others
Tripura	3	Khowai	Scented Lemon	Rice based products	Paddy
Tripura	4	NorthTripura	Black Pepper	Tea processing	Tea
Tripura	5	Sepahijala	Pineapple	Dairy based products	Dairy based products
Tripura	6	SouthTripura	Watermelon	Bakery products	Bakery products
Tripura	7	Unakoti	Pineapple	Multiple fruit processing	Multiple fruit processing
Tripura	8	West Tripura	-	Bakery products	Bakery products
Uttar Pradesh	1	Agra*	Potato	Petha	Petha (Ash gourd)
Uttar Pradesh	2	Aligarh	Mango/Honey	Milk Product	Milk Product
Uttar Pradesh	3	Ambedkar Nagar	-	Chilli	Chilli
Uttar Pradesh	4	Amethi	-	Aonla	Aonla
Uttar Pradesh	5	Amroha	-	Mango	Mango
Uttar Pradesh	6	Auraiya	Mustard	Milk Product (Ghee)	Milk Product (Ghee)
Uttar Pradesh	7	Ayodhya	-	Jaggery	Sugarcane
Uttar Pradesh	8	Azamgarh	-	Basil	Basil
Uttar Pradesh	9	Bagpat	Mango	Jaggery	Sugarcane
Uttar Pradesh	10	Bahraich	Banana	Turmeric	Banana
Uttar Pradesh	11	Ballia	Lentil	Onion	Lentil
Uttar Pradesh	12	Balrampur	Lentil	Corn product	Maize
Uttar Pradesh	13	Banda	Arhar	Oilseed based products	Oilseeds
Uttar Pradesh	14	Barabanki	-	Mint	Mint
Uttar Pradesh	15	Bareilly	-	Milk Product	Milk Product
Uttar Pradesh	16	Basti	Rice (Kala Namak Vr.)	Sugarcane vinegar	Rice (Kala Namak Vr.)
Uttar Pradesh	17	Bhadohi	-	Onion	Onion
Uttar Pradesh	18	Bijnor	-	Jaggery	Sugarcane
Uttar Pradesh	19	Budaun	Bajra	Guava	Guava
Uttar Pradesh	20	Buland Shahar	Basmati Rice & Honey	Milk Based Products	Milk Based Products
Uttar Pradesh	21	Chandauli	-	Tomato	Tomato

Uttar Pradesh	22	Chitrakoot	Gram	Oilseed based product	Oilseeds
Uttar Pradesh	23	Deoria	-	Chilli	Chilli
Uttar Pradesh	24	Etah	-	Chicory	Chicory
Uttar Pradesh	25	Etawah	Mustard	Tomato	Mustard
Uttar Pradesh	26	Farrukhabad*	Potato	Potato	Potato
Uttar Pradesh	27	Fatehpur	Arhar	Aonla	Aonla
Uttar Pradesh	28	Ghazipur	Lentil	Onion	Onion
Uttar Pradesh	29	Gonda	-	Banana	Banana
Uttar Pradesh	30	Gorakhpur	Rice (Kala Namak Vr.)	Banana	Rice (Kala Namak Vr.)
Uttar Pradesh	31	Hamirpur	Gram	Other	Others
Uttar Pradesh	32	Hapur	Rice (Basmati)	Petha	Petha (Ash gourd)
Uttar Pradesh	33	Hardoi	-	Groundnut	Groundnut
Uttar Pradesh	34	Hatharas	Rice (Basmati)	Asafoetida	Asafoetida
Uttar Pradesh	35	Jalaun	Vegetable pea	Pea	Pea
Uttar Pradesh	36	Jaunpur	-	Milk Products	Milk Products
Uttar Pradesh	37	Jhansi	Sesame	Basil	Basil
Uttar Pradesh	38	Kannauj	Potato	Potato	Potato
Uttar Pradesh	39	Kanpur Dehat	Arhar	Milk Products	Milk Products
Uttar Pradesh	40	Kanpur Nagar	Arhar	Bakery Products	Bakery Products
Uttar Pradesh	41	Kasganj	-	Milk products (Ghee)	Milk products (Ghee)
Uttar Pradesh	42	Kaushambi	-	Guava	Guava
Uttar Pradesh	43	Kushinagar	Banana	Turmeric	Banana
Uttar Pradesh	44	Lakhimpur Khiri	-	Banana	Banana
Uttar Pradesh	45	Lalitpur	Urd	Turmeric	Turmeric
Uttar Pradesh	46	Lucknow*	Mango	Mango	Mango
Uttar Pradesh	47	Maharajganj	Rice (Kala Namak Vr.)	Banana	Rice (Kala Namak Vr.)
Uttar Pradesh	48	Mahoba	Betel Vine	Oilseed based product	Oilseeds
Uttar Pradesh	49	Mainpuri	Garlic	Garlic	Garlic
Uttar Pradesh	50	Mathura	Mustard	Milk Products	Milk Products (Peda)
Uttar Pradesh	51	Mau	-	Mango	Mango
Uttar Pradesh	52	Meerut*	Mango	Jaggery	Sugarcane
Uttar Pradesh	53	Mirzapur	Arhar	Tomato	Tomato
Uttar Pradesh	54	Moradabad	-	Honey	Honey
Uttar Pradesh	55	Muzaffarnagar	-	Jaggery	Sugarcane
Uttar Pradesh	56	Pilibhit	-	Jaggery	Sugarcane
Uttar Pradesh	57	Pratapgarh	Aonla	Aonla	Aonla
Uttar Pradesh	58	Prayagraj	-	Guava	Guava
Uttar Pradesh	59	Rae Bareli	-	Aonla	Aonla
Uttar Pradesh	60	Rampur	-	Mint	Mint
Uttar Pradesh	61	Saharanpur*	Mango/Honey	Honey	Honey
Uttar Pradesh	62	Sambhal	-	Mint	Mint
Uttar Pradesh	63	Sant Kabir Ngr	Rice (Kala Namak Vr.)	Bakery Product	Rice (Kala Namak Vr.)
Uttar Pradesh	64	Shahjhapur	-	Jaggery	Sugarcane

Uttar Pradesh	65	Shamli	Basmati Rice	Jaggery	Sugarcane
Uttar Pradesh	66	Shravasti	Banana	Banana	Banana
Uttar Pradesh	67	Siddarth Nagar	Rice (Kala Namak Vr.)	Kala Namak Rice	Kala Namak Rice
Uttar Pradesh	68	Sitapur	-	Mango	Mango
Uttar Pradesh	69	Sonbhadra	Gram	Tomato	Tomato
Uttar Pradesh	70	Sultanpur	-	Mint	Mint
Uttar Pradesh	71	Unnao	-	Mango	Mango
Uttar Pradesh	72	Varanasi	Chilli	Mango	Chilli
Uttarakhand	1	Almora	Chili	Jam, Chutney , pickle (Apricot based)	Apricot
Uttarakhand	2	Bageshwar	Tea	Dal products* (urad, moong, gahat)	Kiwi
Uttarakhand	3	Chamoli	Potato	Citrus based product	fisheries
Uttarakhand	4	Champawat	Horse Gram (Gahat)	Tejpata & spices	Tejpata
Uttarakhand	5	Dehradun	Maize	Bakery product	Bakery product
Uttarakhand	6	Haridwar	Guava/Honey	Mushroom (Button, Milky)	Mushroom
Uttarakhand	7	Nainital	Cinnamon	Fruit juice and squash (peach)	Peach
Uttarakhand	8	Pauri	Finger Millet (Mandua)	Citrus based product (Malta)	Malta
Uttarakhand	9	Pithoragarh	Kidney Bean (rajma)	Turmeric based products	Turmeric
Uttarakhand	10	Rudraprayag	Amaranth (Chaulai)	Amaranthus based products (ladoo etc)	Amaranthus
Uttarakhand	11	Tehri	Ginger	Ginger based products	Ginger
Uttarakhand	12	Udham Singh	Rice	Mango based	Mango
West Bengal	1	Birbhum	Aromatic Rice	Paddy	
West Bengal	2	Darjeeling	Orange	Tea, Kahawa, Coffee, Black Tea	Tea, Kahawa, Coffee, Black Tea
West Bengal	3	Hooghly	Potato	Paddy	Paddy
West Bengal	4	Howrah	Coconut	Coconut	Coconut
West Bengal	5	Jalpaiguri	Pineapple	Pineapple	Pineapple
West Bengal	6	Jhargram	Cashewnut	Cashewnut	Cashewnut
West Bengal	7	Kalimpong	Large Cardamom	Large Cardamom	Large Cardamom
West Bengal	8	Malda	Mango	Mango	Mango
West Bengal	9	Murshidabad	Mango	Mango	Mango
West Bengal	10	Nadia	Mustard	Mustard	Mustard
West Bengal	11	North 24 Parganas	Mustard/Honey	Mustard/Honey	Mustard/Honey
West Bengal	12	Paschim Bardhaman	Sweet Lime	Sweet Lime	Sweet Lime

West Bengal	13	Paschim Medinipur	Sesame	Sesame	Sesame
West Bengal	14	Purba Bardhaman	Aromatic Rice	Aromatic Rice	Aromatic Rice
West Bengal	15	Purba Medinipur	Betelvine	Betelvine	Betelvine
West Bengal	16	Purulia	Mesta (Roselle)	Mesta (Roselle)	Mesta (Roselle)
West Bengal	17	South 24 Parganas	Guava	Guava	Guava
West Bengal	18	Uttar Dinajpur	Aromatic Rice	Aromatic Rice	Aromatic Rice

## PARTICULARS OF CAGDI ESTIMATED INCOME/EXPENSES FROM FINANCIAL YEAR 2022-23 TO 2028-29

Sr. No.	Statewise Detail	Number of Districts	Financial Year	Name of Schemes	Estimated Yearly Expenses (per District)	Estimated Yearly Expenses (in Crores INR)	Working Unit Detail		Estimated Yearly Earning (Percentile)		Estimated Yearly Earning (in Crore INR)	
							National	International	National	International	National	International
1	All States of India	724	2022-23	ODOP/ Others	@1.57	@136.68	@84	NA	100.00%	NA	@581.07	NA
2	All States of India	724	2023-24	ODOP/ Others	@10.38	@7515	@780	NA	100.00%	NA	@3909	NA
3	All States of India	724	2024-25	ODOP/ Others	@25.5	@8462	@2560	@165	60.00%	40.00%	@5660	@7680
4	All States of India	724	2025-26	ODOP/ Others	@30.5	@22082	@3916	@295	60.00%	40.00%	@6889	@9186
5	All States of India	724	2026-27	ODOP/ Others	@50.5	@36562	@4975	@315	60.00%	40.00%	@11407	@15209
6	All States of India	724	2027-28	ODOP/ Others	@155.18	@112350	@22230	@6270	60.00%	40.00%	@35053	@46737
7	All States of India	724	2028-29	ODOP/ Others	@138	@121632	@22230	@6270	60.00%	40.00%	@37949	@50598

## MARKETING UNIT DESCRIPTION

In the financial year 2022-23 by the Central Agricultural Development Institution, the estimated number of districts covered by the nation of India under the minimum support / other price purchase scheme for one product or other agricultural raw / other food product = @ 724

Estimated expenditure on marketing unit per district in the financial year 2022- 23 by Central Agricultural Development Institution = @1.57 crore

Estimated expenditure on marketing units @84 marketing units under one district, one product or other scheme by marketing unit by Central Agricultural Development Institution = @131.88  
OR Other cost =@136.68 crores

Estimated expenditure on marketing unit per district in the financial year 2022- 23 by Central Agricultural Development Institution = @1.51 crore



Estimated expenditure on marketing units by Central Agricultural Development Institution @84 marketing units under one district one product or other plan = **@84 Depo.**

Estimated annual turnover by the Central Agricultural Development Institution in the financial year 2022-23 = **@4132.00 Crores**

Estimated number of marketing units by Central Agricultural Development Institution in the financial year 2023-24 = **@780** Annual income received by Central Agricultural Development Institution from total marketing units in 2023-24 = **@3909 crores**

In the financial year 2023-24 by the Central Agricultural Development Institution, the estimated number of districts covered by the nation of India under the minimum support / other price purchase scheme for one product or other agricultural raw / other food product = **@724**

Estimated expenditure on marketing unit per district in the financial year 2023- 24 by Central Agricultural Development Institution = **@10.38 crore**

Estimated expenditure on marketing units by Central Agricultural Development Institution @780 marketing units under one district one product or other plan = **@7515 Unit/Depo**

Estimated annual turnover by the Central Agricultural Development Institution in the financial year 2023-24 = **@15030.00 crores**

Estimated number of marketing units by Central Agricultural Development Institution in the financial year 2024-25 = **@2560** Annual income received by Central Agricultural Development Institution from total marketing units in 2024-25 = **@5660 crores**

In the financial year 2024-25 by the Central Agricultural Development Institution, the estimated number of districts covered by the nation of India under the Minimum Support / Other Price

Purchase Scheme for one district one product or other agricultural raw / other food product = **@724**  
Estimated expenditure per district of marketing unit by Central Agricultural Development Institution in the financial year 2024-25 = **@ 25.5 crore/district**

Estimated expenditure on marketing units by Central Agricultural Development Institution @2560 marketing units under one district one product or other scheme = **@8462 crore**

Estimated annual turnover by Central Agricultural Development Institution in the financial year 2024-25 = **@43877.00 crore**

Estimated number of marketing units by Central Agricultural Development Institution in the financial year 2025-26 = **@3916** Annual income received by Central Agricultural Development Institution from total marketing units in 2025-26 = **@6889 crores**

In the financial year **2025-26** by the Central Agricultural Development Institution, the estimated number of districts covered in the nation of India under the minimum support / other price purchase scheme for one product or other agricultural raw / other food product = **@ 724**

Estimated expenditure on per district of marketing unit by Central Agricultural Development Institution in the financial year **2025-26 = @ 30.5 crore/district**

Estimated expenditure on marketing units by Central Agricultural Development Institution **@ 3916** marketing units under one district one product or other plan = **@22082 crore**

Estimated annual turnover by Central Agricultural Development Institution in the financial year **2025-26 = @114499.00 crore**

Estimated number of marketing units by Central Agricultural Development Institution in the financial year **2028-29 =@4975** Annual income received by Central Agricultural Development Institution from total marketing units in **2028-29= @11407 crores**

In the financial year **2028-29** by the Central Agricultural Development Institution, the estimated number of districts covered in the country of India under the minimum support / other price purchase scheme for one product or other agricultural raw/other food product = **@724**

Estimated expenditure on per district of marketing unit by Central Agricultural Development Institution in the financial year **2028-29= @50.5 crore/district**

Estimated expenditure on marketing units by Central Agricultural Development Institution **@4975** marketing units under one district one product or other scheme = **@36562 crore**

Estimated annual turnover by Central Agricultural Development Institution in the financial year **2028-29 = @189580.00 crores**

Estimated number of marketing units by Central Agricultural Development Institution in the financial year **2028-29 = @22230** Annual income received by Central Agricultural Development Institution from total marketing units in **2028-29 = @35053 crores**

In the financial year **2028-29** by the Central Agricultural Development Institution, the estimated number of districts covered by the nation of India under the minimum support / other price purchase scheme for one product or other agricultural raw / other food product = **@724**

Estimated expenditure on copy of marketing unit by Central Agricultural Development Institution in the financial year **2028-29 = @155.18 crore/district**

Estimated expenditure on marketing units **@22230** under one district one product or other scheme by marketing unit by Central Agricultural Development Institution = **@112350 crore**

Estimated annual turnover to be done by Kendriya Krishi Vikas Sansthan in the financial year **2028-29 = @525555.00 crore**

Estimated number of marketing units by Central Agricultural Development Institution in the financial year **2028-29 = @22230** Annual income received by Central Agricultural Development Institution from total marketing units in **2028-29 = @37949 crores**

In the financial year **2028-29** by the Central Agricultural Development Institution, the minimum limit for one district one product or other agricultural raw/other food product=**@724**

Estimated expenditure on copy of marketing unit by Central Agricultural Development Institution in the financial year **2028-29 = @138.00 crore/district**

Estimated expenditure on marketing units @22230 under one district one product or other scheme by marketing unit by Central Agricultural Development Institution = **@21912.40 Crore**

Estimated annual turnover to be done by Kendriya Krishi Vikas Sansthan in the financial year **2028-29 = @1583722.00 Crores**

Central Agricultural Development Institution (formerly known/trade name Uttar Pradesh Krishi Vikas Sansthan) 100% free from corruption like intention/covenant/karmana or to develop the method of creation or creation of servants through various means or transparent educational/educational/educational Income-expenditure details to be received in short/long certification/other courses and training for the creation of honest/benevolent servants by developing other methods- Number of jobs sanctioned by Kendriya Krishi Vikas Sansthan = **@1.5 lacs**

Approximate number (in percentage) of institutional sanctioned jobs under management system out of **@1.5 lakh jobs** sanctioned by Central Agricultural Development Institution = **@15%**

Approximate number of managerial seats for institutional sanctioned jobs under management system in **@1.5 lacs** jobs sanctioned by Central Agricultural Development Institution = **@22500** (twenty two thousand five hundred only)

Approximate percentage of higher graded administrative seats = **@60%** or **@ 13500** (thirteen thousand five hundred) seats in institutional sanctioned **@ 22500** jobs under management system by Central Agricultural Development Institution, institutional sanctioned **@22500** seats higher in jobs Fee per candidate applicable on educational/educational fees in categorized administrative seats = **@12.5 (Twelve Lacs Fifty Thousand) Lacs**

Approximate percentage number of managerial graded seats in jobs relative to institutional sanctioned seats **@22500** under management system by Central Agricultural Development Institution = **@20%** (twenty) = **@4500** (four thousand five hundred)

Fee per candidate applicable on higher managerial graded seats in the jobs in respect of institutional approved **@22500** seats under the management seat arrangement by the Central Agricultural Development Institution = **@22500**

Approximate percentage number of categorized seats in jobs in high accounting etc. relative to the institutional sanctioned **@22500** seats under the management system by the Central Agricultural

Development Institution = @20% = 4500 (four thousand five hundred) seats Fee per candidate applicable on categorized seats in jobs in respect of higher accounts etc. in respect of institutional sanctioned @22500 seats under management seat arrangement by Central Agricultural Development Institution = @ 5.00 lacs

Institutionally approved by the Central Agricultural Development Institution under the management system, for the highly rated administrative, highly managerial graded, high accounting, etc. categorized jobs, in creating corruption-free/honest/national-beneficial servants, to make India an internationally developed nation in the establishment of a global level with the traditional education system of the East. Modern education system or youth in the course without confusion Commuting time/semester=@2 years or @6 semesters (@4 months per semester)

Estimated number of seats for International Level High Graded Administrative by Central Agricultural Development Institution in the financial year 2023-24 @ 13500 (20% against 60% of 22500) = @2700

Estimated number of seats for International Level High Graded Administrative Jobs by Central Agricultural Development Institution in the financial year 2024- 25 @ 13500 (20% against 60% of 22500) = @2700

Estimated number of seats for International Level High Graded Administrative Jobs by Central Agricultural Development Institution in the financial year 2025- 26 @ 13500 (20% against 60% of 22500) = @2700

Estimated number of seats for International Level High Graded Administrative Jobs by Central Agricultural Development Institution in the financial year 2026- 27 @ 13500 (20% against 60% of 22500) = @2700

Estimated number of seats for International Level High Graded Administrative Jobs by Central Agricultural Development Institution in the financial year 2027- 28 @ 13500 (20% against 60% of 22500) = @2700

Approximate number of seats allotted/sanctioned by Central Agricultural Development Institution in the financial year 2024-25 against international level sanctioned @ 4500 highly rated managerial jobs = @1800 (4500 on behalf of 4500 seat)

Approximate number of seats allotted/sanctioned by Central Agricultural Development Institution in the financial year 2025-26 against international level sanctioned @ 4500 highly rated managerial jobs = @1800 (4500 against 4500)

Approximate number of seats allotted/sanctioned by Central Agricultural Development Institution in the financial year 2028-29 against international level sanctioned @ 4500 highly rated managerial jobs = @900 (20% against 4500)

Estimated number of seats for International Level Higher Accounts etc. graded jobs by Central Agricultural Development Institution in the financial year 2022- 23 = @2738

Estimated number of seats for international level higher accounting etc. graded jobs by Central Agricultural Development Institution in the financial year **2023- 24 = @1762**

Institutionally approved by the Central Agricultural Development Institution under the management system, for the highly rated administrative, highly managerial graded, high accounting, etc. categorized jobs, in creating corruption-free/honest/national-beneficial servants, to make India an internationally developed nation in the establishment of a global level with the traditional education system of the East. The income-expenditure brochure received by the Institution on modern education system or the course without confusion to the youth:-

In the financial year **2023-24** by the Central Agricultural Development Institution, the International Level High Graded Administrative @13500 (Related to 60% of 22500)

Estimated income in the order of **@2700 seats = @2700 \* 12.5 lacs = @337.50 crore**

In the financial year **2024-25** by the Central Agricultural Development Institution, the estimated income to be received on **@ 2700** seats in the order of International Level High Ranked Administrative **@ 13500 (20% against 60% of 22500) = @ 2700 \* 12.5 lakh = @ 337.50 crore**

In the financial year **2025-26** by the Central Agricultural Development Institution, the estimated income to be received on **@ 2700** seats in the order of International Level High Graded Administrative **@ 13500 (20% against 60% of 22500) = @ 2700 \* 12.5 lakh = @ 337.50 crore**

In the financial year **2028-29** by the Central Agricultural Development Institution, the estimated income to be received on **@ 2700** seats in the order of International Level High Ranked Administrative **@ 13500 (20% against 60% of 22500) = @ 2700 \* 12.5 lakh = @ 337.50 crore**

In the financial year **2028-29** by the Central Agricultural Development Institution, the estimated income to be received on **@ 2700** seats in the order of International Level High Graded Administrative **@ 13500 (20% against 60% of 22500) = @ 2700 \* 12.5 lakh = @ 337.50 crore**

In the financial year **2024-25** by the Central Agricultural Development Institution, the estimated income to be received on **@ 1800** seats in the order of International Level High Ranked Managerial **@ 4500 (40% against 20% of 22500) = @1800 \* 7.5 lakh = @ 135 crore**

In the financial year **2025-26** by the Central Agricultural Development Institution, the estimated income to be received on **@ 1800** seats in the order of international level high graded managerial **@4500 (40% against 20% of @22500) = @1800 \* 7.5 lakh = @135 crore**

International level in the financial year **2023-24** by the Central Agricultural Development Institution= Estimated income to be received on **@900** seats in the order of higher graded managerial **@4500 (20% against 20% of 22500) = @2700 \* 7.5 lakh = @67.5 crore**

Estimated income to be received on **@2738** seats in the financial year **2022-23** by the Central Agricultural Development Institution in respect of **@4500** of the International Level High Graded Accounts = **@2738 \* 5 lacs = @136.90 crores**

Estimated income to be received on @1762 seats in the financial year 2023-24 by Central Agricultural Development Institution in respect of @4500 of International Level High Graded Accounts = @1762 \* 5 lacs = @88.10 crore

Estimated income to be received by the Central Agricultural Development Institution from the financial year 2022-23 to 2028-29 under educational/academical system = @1687.50+@337.50+@225=@2250 crore

The estimated minimum expenditure to be/come in the educational/training system from the financial year 2022-23 to 2028-29 by the Central Agricultural Development Institution = @2250\*40% = @900 crores

The estimated maximum expenditure to be/come in the educational/educational system from the financial year 2022-23 to 2028-29 by the Central Agricultural Development Institution =@2250\*60%=@1350 crore

Estimated net income to be received by Central Agricultural Development Institution from the financial year 2022-23 to 2028-29 under educational/ educational system (relative to mean expenditure) = @1125

Detail-wise details of the budget approved by the Central / State Government such as Uttar Pradesh State Government and others to the Central Agricultural Development Institution:-

Order file number 17-1/2018-D.P. of the Department of Livestock, Milk and Fisheries of the Ministry of Agriculture and Farmers Welfare in the order of reference number PMOPG/D0/2018/0296165 dated 17-08-2018 to the Central Agricultural Development Institution in the order of Hon'ble Prime Minister's Office. On September 19, 2018, on the order of institutional demand proposal, the amount approved from the Central Government = 11931.80 crore

Order of Ministry of Food Processing Industries, Government of India, New Delhi for High Automatic Mega Food Park (Central Level Government High Industrial Unit) No. 01 on International Standards by Central Agricultural Development Institution File No. 12033/69/2019-PC dated 07-11-2019 Prime Minister In the order of Kisan Sampada Yojana, institutional sanctioned / proposed estimated amount to be completed in the financial year 2022-23 to 2028-29 = @22500 crore

## Other State Level Budget/Grants/Graduate Approvals

01. Central Agricultural Development Institution(Pre-Amendment Trade/Previous Name Uttar Pradesh Krishi Vikas Sansthan) has received departmental/ministerial approval to cover the budget/grant/subsidy etc. category under the Uttar Pradesh Food Processing Industries Policy-2017.

02. Central Agricultural Development Institution (Pre-amendment Trade/Previous Name Uttar Pradesh Krishi Vikas Sansthan) has received departmental/ministerial approval for coverage in the category of budget/grant/subsidy etc. under Uttar Pradesh Milk Policy-2018.

03. Under the Uttar Pradesh Industrial Investment and Employment Promotion Policy-2017, the Central Agricultural Development Institution (Pre-Amendment Trade/Previous Name Uttar Pradesh

Krishi Vikas Sanstha) received departmental/ministerial approval of the category of budget/grant/subsidy etc. and other departmental /Ministerial Sanctions/Proceedings etc. prevailing. A detailed description of the estimated expenditure or amount to be incurred by the Central Agricultural Development Institution on the possible marketing / sales units of Smart Cities / Mandal / District / Tehsil / Block / Nyaya Panchayat / Town Area / other or institutional central level indirect government units of India:-

**01.Estimated/Proposed No. of Potential Large Marketing Units/Units=@ 3705**

01(01). Estimated number of employment potential in the large marketing unit/units =**@9,26,250 (250 employees/officers/others per unit)**

**(02)Estimated/proposed number of potential small marketing units/units = @7125**

02(01) Estimated employment of potential small marketing units/units Number = **@10,68,750** (150 employees/officers/others per unit)

**03.Estimated/proposed number of other marketing units/units possible =@9533**

03(01). Expected employment potential in other marketing units/units Number = **@ 1,42,995 (15 employees/officers/others per unit)**

Detail:-Total estimated number of potential employment in Marketing/Sales units =**@21,62,406 (Twenty One Lakh Sixty Two Thousand Four Hundred Six)**

Estimated/proposed @3705 of the major marketing units/units proposed by the Central Agricultural Development Institution from the financial year **2022-23 to 2028-29=@3705 \*1.57 crores=@5816.85 crores**

The estimated indirect expenditure of the small marketing units/units proposed by the Central Agricultural Development Institution from the financial year **2022- 23 to 2028-29 is @7125 from the financial year 2022-23 to 2028-29. @ 7125 \* 50 lacs = @3562.50 Crore**

The estimated indirect expenditure of other / micro marketing units / units proposed by the Central Agricultural Development Institution from the financial year 2022-23 to 2028-29 at the estimated **@7125 from the financial year 2022- 23 to 2028-29 = @ 9533 \* 12 lacs =@1143.96 Cr**

Indirect total expenditure on large, small, micro/other marketing units proposed by the Central Agricultural Development Institution from the financial year **2022- 23 to 2028-29 = @10523.31 crore**

Indirect monthly income to the Central Agricultural Development Institution = @10523.31 crore \* @13% = @1368.03 crore on large, small, micro/other marketing units proposed by the Central Agricultural Development Institution from the financial year **2022-23 to 2028-29**

Indirect annual income to the Central Agricultural Development Institution on the proposed large, small, micro/other marketing units from the financial year **2022-23 to 2028-29 by the Central Agricultural Development Institution =@16416.303 crore**

Central Agricultural Development Institution on the proposed major, small, micro/other marketing units from the financial year 2023-24 to 2028-29 by the Central Agricultural Development Institution.

Indirect Annual Turnover from Indirect Assets in increasing order  
**=@164163.00 crore to @1641630.00 Crore**

Note- The major, small, micro / other marketing units proposed by the Central Agricultural Development Institution from the financial year **2022-23 to 2028-29** will be indirect assets to be allocated to the institutional public / other through which the institutional allocated sub-agency, depot Central / State level indirect employment will be created in the form of etc., whose burden will be borne by the sub-agency, depot etc.

### **From the financial year 2022-23 to 2028-29, the detailed description of the central level direct government units by the Central Agricultural Development Institution:-**

Central Agricultural Development Institution (Pre-Amendment Trade/Previous Name Uttar Pradesh Krishi Vikas Sansthan) Nyaya Panchayat/Other Level Farmer Service Center / Mini Collection Center / Estimated / Proposed Number of Milk Collection Centers =@**33888** (Thirty three thousand eight hundred eighty)

Kendriya Krishi Vikas Sansthan (Pre-revised Trade/Previous Name Uttar Pradesh Krishi Vikas Sansthan) Estimated expenditure at Nyaya Panchayat level @ **22 lakh** per farmer service center/mini collection centre/milk collection center from financial year **2022-23 to 2028-29**  
(Extended/Differentiated)=@**22\*33888=745536 lacs=@7455.36 Cr**

Central Agricultural Development Institution (Pre-revised Trade/Previous Name Uttar Pradesh Krishi Vikas Sansthan) Turnover of Nyaya Panchayat Level Centers from the financial year **2022-23 to 2028-29 =@171 crore to @74553 crore**

Central Agricultural Development Institution (Pre-revised Trade/Previous Name Uttar Pradesh Krishi Vikas Sansthan) for each of the states of the nation of India by the Ministry of Agriculture and allied areas / regions or Food Processing Industries for each division / zone from the financial year **2022-23 to 2028-29**. Approximate number of central level government industrial (large, small, medium, micro) units to be set up in rural areas for proposed areas / areas under one district one product plan issued or institutionalized = @ **83 (Thirty- three)**

Central Agricultural Development Institution (Pre-revised Trade/Previous Name Uttar Pradesh Krishi Vikas Sansthan) for each of the states of the nation of India by the Ministry of Agriculture



and allied areas / regions or Food Processing Industries for each division / zone from the financial year **2022-23 to 2028-29**. Central level government infrastructure development level industrial (major, small, large, small, Approximate Expenditure on / to be incurred on Medium, Micro) Units = **@483\*@83=@40089 Crore**

Central Agricultural Development Institution (Pre-revised Trade/Previous Name Uttar Pradesh Krishi Vikas Sansthan) from the financial year **2023-24 to 2027- 28** at the central level government infrastructure development level industrial (major, small, medium, micro) units Over(Extended/Varied)=**@1500 Crore** (One Thousand Five Hundred) to **@489000 Crore** (Four Lacs Ninety Thousand Crore INR.)

## **Action plan of Central Agricultural Development Institution from 2022-23 to 2028–29**

The Institution has provided to the State of Uttar Pradesh the Agricultural Product Processing Unit, Banking/Financial (Teaching/Training & Service) Unit, Cow Protection Home Unit, Insurance (Teaching/ Training & Service) Unit, Agricultural Plant (Teaching/Training, Construction) Acs, Organic/Chemical Fertilizer (Teaching/Training Manufacturing) Unit, Research (Agricultural Product Hybridization, Cow Hybridization, Organic Hybridization etc.) Unit, Regular rates stall/unit/milk refrigeration Home/Dairy Products processing unit/of the estimated number of building broad -level joint large industrial unit or institution in the state of Uttar Pradesh & Other States Or/And District wise **Micro/Small/Medium Industrial Unit with Cluster based for ODOP** and Other Scheme/s = **@83 + @655 = @738**

NON-NPA KRISHAK BANKING GUARANTEE SCHEME and Dairy Entrepreneurship Development Scheme(D.E.D.S and Other Milk Scheme/s) or other milk based policy or scheme/schemes are implemented by Central Agricultural Development Institution under Zero Corruption Based Policy at Mandal/Tehsil/District/ Nyaya Panchayat / Gram Sabha Level Small Industrial Units (Granted) = **@50000**

Credit limit on small scale industrial units (subsidized sources to department of animal husbandry, dairies & fisheries ministry of agriculture and farmer welfare **order file no.17-1/2018** dated 19-09-2018 )= **@ 66.20** lakhs per unit (combined cold storage, dairy units with a daily capacity of 5000 liters, milk processing equipment).

Estimated number of district/tehsil level direct/ indirect (including agency etc.) for processing pure raw milk under the control of Central Agricultural Development Institution = @ **813**

District/Tehsil level direct/indirect (including agency etc.) loan for processing pure raw milk under the control of Central Agricultural Development Institution = @**4** lakh per unit (Under state level loan scheme or others with non npa krishak banking guarantee scheme/schemes).

Under the control of Central Agricultural Development Institution(till loan payment) D.E.D.S and Other Milk Scheme/s Estimated number of dairy parlors dairy under the plan = @ **27000**

Loan on dairy parlors under the scheme (subsidized) = @3 lakhs per dairy parlor

Under the control of Central Agricultural Development Institution (till loan payment) D.E.D.S and Other Milk Scheme/s. Number of animal clinics under the plan = @ **14700**

Loan on animal clinics under the scheme (subsidized) = @ **4. 60** lakhs per animal clinic

Under the control of Central Agricultural Development Institution (till loan payment) D.E.D.S and Other Milk Scheme/s Estimated number of milk tankers under the plan = @ **125**

Milk tankers loan under the scheme (subsidized) = @ **26. 50** lakhs per tanker

Estimated number of Farmers Service Centers/Mini Collection Centers/Milk Products Procurement Centers = 8137 under Central Agricultural Development Institutional control (including through agency etc.)

Estimated number of vermicompost units under DEDS scheme under control of Central Agricultural Development Institution (till loan payment) = @ **27000**

Loan on vermicompost unit under the scheme (subsidized) = **25200**

Central Agricultural Development Institution under control (till loan repayment) of loans subsidized for hybrid animals under D.E.D.S and Other Milk Scheme/s plan= @ **40.40** lakh farmers (marginal or weak income poor farmers to higher income farmers)

D.E.D.S and Other Milk Scheme/s by Central Agricultural Development Institution Loans for hybrid animals under the scheme (subsidized) = @**70000**

Estimated unit number of calf/calves/other (for cows / buffaloes)of hybrid animals under the scheme = @**14000**

Loan (subsidized) on the estimated units of calf / calves / other (for cows / buffaloes) of hybrid animals under D.E.D.S and Other Milk Scheme/s scheme = @ **9.70** lakhs per unit for 20 calves

**NOTE-All credit/loane scheme/schemes of institution under the non npa krishak banking guarantee scheme/s.**

## **Under the Dairy Entrepreneurship Development Scheme (D.E.D.S and Other Milk Scheme/s), the amount subsidized on the loan obtained by DBT: -**

For General Category = @25%

S C / S T / O B C = @33.33%

Estimated number of jobs created by the Central Agricultural Development Institution in the state of Uttar Pradesh through contract or other means = @1.5 lakhs

Number of sanctioned posts = @36916

Number of indirectly created employment through Central Agricultural Development Institution = @5.25 lakh

Estimated number of marginal or very poor farming/other farmer/s/other registered families member benefited through Central Agricultural Development Institution BY DBT = @40.40 lakh or total no. of All states = @3.5 Crore

Estimated registered @3.5 crore Krishak or other family or families will nominate with direct benefit transfer scheme/schemes agricultural families

All the policies of the Central Agricultural Development Institution will be variable in the order of the farmer / people / nation / institution beneficial schemes.

## **MARKETING / SALES UNIT**

The details of the estimated number of Smart Cities / Mandal / District / Tehsil / Block Nyaya Panchayat / Town Area / Other Level Potential Marketing Sales Units of India by the Central Agricultural Development Institution: -

Potential Mass Marketing Unit = @3705

Estimated number of potential jobs in the mass marketing unit = @9,26,250 (250 employees / officers / others per unit)

Potential Small Marketing Unit = @ 7125

Estimated number of potential employment in potential small marketing unit = 10,68,750 (150 employees / officers / others per unit)

Potential Macro Marketing Unit = @ 8137

Estimated number of potential jobs in potential large marketing units = @24,411 (03 employees / officers / others per unit)

Potential Other Marketing Sales Unit Number = @9533

Estimated number of potential jobs in potential other marketing sales units = @1,42,955 (15 employees / officers / others per unit)

Total estimated number of potential jobs in Marketing Sales Unit = @21,62,406

Estimated number of livestock house / animal protection home / institutional veterinary hospital / biological power plant / institutional large vermicompost unit / cow cattle (livestock) cadaver house under livestock policy for Uttar Pradesh

Estimated number of employment in Divisional level Cow Protection Home / Animal Protection Home = @ 975 \* 2 = 1950

Estimated number of employment in District level Small Cow Protection Home / Animal Protection Home = @ 475 \* 16 = 7600

Estimated number of employment in District level large institutional veterinary hospital = @ 975 \* 2 = 1950

Estimated number of employment in District Level Small Institutional Veterinary Hospital = @ 475 \* 16 = 7600

Estimated number of employment in District level large power plant = @ 975 \* 2 = 1950

Estimated number of employment in District level small power plant = @ 475 \* 16 = 7600

Estimated number of employment in the District level Large Institutional Vermicompost Unit = @ 975 \* 2 = 1950

Estimated number of employment in District Level Small Institutional Vermicompost Unit = @ 475 \* 16 = 7600

Estimated number of employment in District level bovine (livestock) crematorium = @ 40 \* 18 = 720

## Medicinal Agricultural Product Scheme

The Central Agricultural Development Institution has a provision of providing credit to farmers in all the regions of India, by providing them credit facilities, such as = 10,000 per acre of credit, and

to provide them training of medicinal agricultural plants free of cost, for which the Institution has been identified / registered. Ensuring availability of high quality fertilizers / seeds / others to farmers that has been produced by farmers medicinal agricultural products (Raw Material) selling produce materials not less than half price fixed by the government of india to support the farmers or will provide them one and a half time more price than the money they spend on their farm . There are 140 plants that came under the category of medicinal plants and to motivate the farmers to indulge in the farming of medicinal plants there is a provision of providing them subsidy of @ 30%, @ 50%, @ 75% under the Ministry of AYUSH Government of the Ministry of AYUSH Medicinal Plants Mission, respectively, as prescribed by the Ministry of AYUSH Ministry of India, on the production of registered medicinal agricultural products. The system of direct transfer is a provision under the zero corruption based policy.

Free medicinal training to farmers, registered / identified by the Institution (under Medicinal Agricultural Products Scheme) for medicinal agricultural products / seed manure / others by providing facility to farmers registered / identified under Medicinal Agricultural Products Scheme on the basis of timely changes or others. Providing sowing, irrigation, harvesting, subsequent purchase and purchase of return (including interest) Return via the selling of their produced materials (registered / marked the medicinal product by the agricultural farmers) (raw material for all category) provisions are ensured.

The Medicinal Agricultural Produce Scheme will be variable based on seasonal changes. Expenditure incurred on seeds, sowing, irrigation, harvesting and other expenses on the farmers will be refunded from the funds received by the Institution from the credited / identified farmers after the sale by the Institution, ie from the funds received / sold by the Institution. Product plan or medicinal plant mission for ministry of AYUSH India) Plan on the basis of seasonal / geographical changes No will be provided. Panchakarma unit under the Medicinal Plant Mission in which K.G.M.U (Medical College Lucknow) and Uttar Pradesh Agricultural Development Institution changed name Panchakarma unit to be established by Central Agricultural Development Institution etc.

Estimated number of district level registered high / medium / marginal farmers under medicinal scheme = @ **10000**

Estimated cost (in Rs.) on credit with credit given to district level registered high / medium / marginal farmers under medicinal scheme = **Rs.15000 to @ Rs.20000** per farmer or cost per bigha (either one)

Estimated income per district of high / medium / marginal farmers registered under medicinal scheme = @ **50000 to @ 70000**. District level registered annual yield in 1 bigha land by medicinal scheme registered high / medium / marginal farmers = @ **2**

# REPORT OR NOTE-:

The above detail of the estimated cost or expenditure or cost to come from the financial year **2022-23** to the financial year **2028-29** on human resources such as institutional created investment/marketing or managerial or administrative/administrative or all other categories of employment Etc. such as experiment/trial implementation will be included in the project report.

Estimated Costs to come from financial year **2022-23** to financial year **2028-29** on farmers/people/others involved in experimental/tested implementation such as institutional generated investment/marketing or managerial or administrative/administrative or all other categories of self-employment such as institutional registered schemes/Estimated cost or expenditure or cost will be included in the said part of the detailed project report.



# केन्द्रीय कृषि विकास संस्थान

प्रस्तावित अथवा संस्थागत अनुमोदित उत्तर प्रदेश राज्य मुख्यालय ब्लॉक B छठा तल पिकअप भवन विभूति खंड लखनऊ  
उत्तर प्रदेश 226010 | मोबाइल संख्या : 8887121498

## केन्द्रीय कृषि विकास संस्थान का संक्षिप्त इतिहास

उत्तर प्रदेश कृषि विकास संस्थान (वर्तमान प्रचलित/ट्रेड नाम केन्द्रीय कृषि विकास संस्थान) द्वारा किए गए शोध के अनुसार ग्राम पंचायत से लेकर शासकीय/अशासकीय/अन्य व्यवस्थाओं में व्याप्त संगठित भ्रष्टाचार जो कि भारतवर्ष को विकसित राष्ट्र स्थापित किए जाने हेतु "अवरोधक" है, पाया गया। उत्तर प्रदेश कृषि विकास संस्थान कृषि/कृषक अंश हेतु किए गए विभिन्न प्रयोगों, परीक्षण के उपरांत उत्तर प्रदेश कृषि विकास संस्थान द्वारा प्रस्तुत किए गए विभिन्न प्रस्तावों यथा कृषकों की आत्महत्या के मुख्य कारक बैंक ऋण अथवा इसमें संबन्धित संगठित भ्रष्टाचार द्वारा प्रभावित होना अथवा इससे कृषकों को निजात दिलाने हेतु प्रस्ताव प्रस्तुत किया गया। एक शोध के दौरान यह पाया गया की ग्रामीण स्तरीय सार्वजनिक बैंकों अथवा अन्य बैंकों से प्राप्त होने वाले ऋण को (अति निर्धन कृषक लगभग @44%) को बैंक दलालों के माध्यम से ही दलाली एवं रिश्वत के सम्पूर्ण माध्यमों से ही बैंक ऋण कृषक को प्राप्त हो पाता है और ऋण पर कम ब्याज अथवा अनुदान आदि के लालच अथवा मजबूरी में ऋण प्राप्त किया जाता है। सरकारी कृषि योजनाओं में ऋण प्राप्त किये जाने हेतु प्रत्यक्ष रिश्वत @5% से @10% बैंकों के नाम अथवा @10% से @20% दलाली अथवा फाइलों के नाम पर अप्रत्यक्ष रूप से खर्च हो जाता है। इस रिश्वत खोरी में अप्रत्यक्ष रूप से फाइलों के नाम पर लिए जाने वाले दलाली अथवा फाइलों के नाम पर लिए जाने वाले धन का भुगतान प्रस्तावित अति निर्धन/ मझौले लगभग @44% अति अल्प आय कृषक वर्ग द्वारा यह सामान्य उधारी के बजाय स्वाभाविक भुगतान के माध्यम से कृषि / अन्य सरकारी योजनाओं में ऋण प्राप्त होने के उपरांत ब्याज सहित वापसी के आधार पर साहूकारों या ब्याजखोरों के माध्यम से प्राप्त किया जाता है। सरकारी कृषि योजनाओं में ब्याज उपरांत/अन्य अनुदान माध्यमों का ऋण प्राप्त करने में शासकीय स्वीकृतियों एवं अन्य कार्यवाहियों में लगभग @1 माह से @3 अथवा @5 अथवा @7 माह का समय लगने से कृषकों को मजबूर कराते हुए उनके द्वारा प्रस्तावित ऋण को प्राप्त करने में तमाम शासकीय अन्य समस्याओं को झेलने से उस ऋण को प्राप्त किए जाने के फलस्वरूप उस ऋण के प्रति कृषकों (ऋणी) के मन में प्रायः कुंठा पैदा होना पाया गया। कुंठा के दृष्टिगत ऋण वसूली दौरान आत्महत्या आदि मामले सामने आए। उत्तर प्रदेश कृषि विकास संस्थान वर्तमान में प्रचलित ट्रेड नाम केन्द्रीय कृषि विकास संस्थान देश के कृषि प्रक्षेत्र में व्याप्त संगठित भ्रष्टाचार पर लगभग सम्पूर्ण विराम/कार्यवाही करते/कराते हुए केंद्र/राज्य सरकार की जनहितकारी योजनाओं को धरातल पर भौतिक क्रियान्वयन हेतु माननीय प्रधानमंत्री जी भारत सरकार एवं माननीय मुख्यमंत्री जी उत्तर प्रदेश के संरक्षण में अथवा अनुमोदनोपरांत ज़ीरो टोलरेंस अथवा संस्थागत ज़ीरो करप्शन बेस्ट पॉलिसी के अंतर्गत कार्य कर रही है। संस्थान द्वारा माननीय प्रधानमंत्री जी भारत सरकार एवं माननीय मुख्यमंत्री जी उत्तर प्रदेश शासन के ज़ीरो टोलरेंस अथवा संस्थागत ज़ीरो करप्शन बेस्ट पॉलिसी के अंतर्गत संस्थागत योजनाओं/परियोजनाओं का भौतिक क्रियान्वयन हेतु प्रतिबद्ध होगी। उत्तर प्रदेश कृषि विकास संस्थान वर्तमान केन्द्रीय कृषि विकास संस्थान द्वारा कृषकों की विभिन्न समस्याएँ तथा आत्महत्या के कारक/ कारण/निवारण के शोध के दौरान यह पाया गया की कृषक आत्महत्या के पीछे बैंक ऋण तथा किसान क्रेडिट कार्ड अथवा कृषि संबन्धित ऋण ही लगभग @90% कारक रहा है। जांच के दौरान यह पाया गया की अतिसूक्ष्म श्रेणी के कृषक तथा @1 बीघे से @5 बीघे तक के कृषकों द्वारा बैंक से प्राप्त किए गए कृषि ऋण का पारिवारिक खर्च के उपरांत कृषि उत्पादित शेष बचे कृषि उत्पाद के बिकवाली उपरांत कृषि ऋण का निपटान करना लगभग नामुमकिन होता है इसके पीछे मुख्य कारण बैंक द्वारा कृषकों को अधिकतम बैंक दलालों के माध्यम से डील करवाना और कृषकों को सही जानकारी से कोसों दूर रखना प्रायः पाया गया। इसके साथ ही साथ बैंकों द्वारा ऋण कारोबार किए जाने हेतु प्राप्त किए गए पुनर्वित्त को किसानों को अधिक रिश्वत/दलाली के लालच में कर्ज़ से दबे अथवा एन 0 पी 0 ए 0 हुए असेट्स पर पुनर्वित्त करने एवं एन 0 पी 0 ए 0 का बोझ देश की अर्थव्यवस्था में सम्मिलित

कराते हुए मुद्रास्फीति के वृद्धि में सहायक आदि के मामले दृष्टिगत हुए। उक्त के क्रम में माननीय मुख्यमंत्री कार्यालय उत्तर प्रदेश शासन द्वारा जारी आदेश संख्या 15157170045184 के क्रम में कृषि विभाग उत्तर प्रदेश से जारी संस्तुति आदेश संख्या प्रसार-265 दिनांक 01-06-2016, प्रसार-475 दिनांक 20-07-2016 एवं पत्रांक प्रसार-718 दिनांक 09-09-2016 के क्रम में कृषि निदेशालय उत्तर प्रदेश प्रसार अनुभाग द्वारा जारी पत्रांक प्रसार 2027/जनसुनवाइ/2017-18/दिनांक 02 फ़रवरी 2018 द्वारा कार्यालय उप कृषि निदेशक द्वारा जारी जांच आदेश पत्रांक-उ0 कृ0 नि0 3310 दिनांक 23 फ़रवरी 2018 के क्रम में संबद्धता संस्तुति जांच आदेश दिनांक 24 फ़रवरी 2018 जारी किया गया जिसके आधार पर माननीय मुख्यमंत्री कार्यालय से जारी आदेश संख्या 11157160022592, 1515180032594 को अनुमोदन/स्वीकृति प्राप्त हुआ। संस्थान द्वारा श्रीमान अपर मुख्य सचिव/सचिव/कृषि विभाग उत्तर प्रदेश शासन को माननीय मुख्यमंत्री कार्यालय से जारी आदेश संख्या 15157180182726 के क्रम में NABARD द्वारा पुनर्वित्त उपलब्ध कराये जाने हेतु उत्तर प्रदेश शासन द्वारा जारी शासनादेश/आदेश संख्या 1228/12-5-2018-सा0-83/2018 लखनऊ दिनांक 04 अक्टूबर 2018 द्वारा संस्थान को अनापत्ति प्राप्त हुआ अथवा कार्यवाही सुनिश्चित हुआ।

## केंद्र सरकार द्वारा जारी न्यूनतम समर्थन मूल्य (MSP) पर संस्थागत खरीद प्रस्ताव

उत्तर प्रदेश राज्य सरकार को उत्तर प्रदेश कृषि विकास संस्थान द्वारा ग्राम सभा स्तर पर कृषकों की सदस्यता कराते हुए उनके द्वारा उत्पादित कृषि कच्चा उत्पाद अथवा खाद्यान्न/धान/गेहूँ की MSP पर खरीद कराते हुए न्याय पंचायत स्तर पर कृषक सेवा केंद्र स्थापित करते हुए खरीददारी की व्यवस्था सुनिश्चित किया जाएगा। लगभग @44% ऐसे कृषक जो स्वयं द्वारा उत्पादित धान/गेहूँ की बिकवाली क्रय केन्द्रों के दूरी के कारण जिनकी बिक्री क्षमता @1 कुंटल से @5 कुंटल तक होती है, नहीं कर पाते हैं। @66% कृषकों के @76% कृषकों का धान/गेहूँ की बिकवाली क्षमता @5 कुंटल से @15 कुंटल तक होती है उन्हें दूरी के कारण किसी अन्य माध्यमों का सहारा लेते हुए अपने उपज को औने-पौने दाम पर बेचने पर मजबूर होना पड़ता है। कृषक सेवा केंद्र की स्थापना न्यायपंचायत स्तर के होने पर बिकवाली समस्या का समाधान सुनिश्चित होना उचित पाया गया। साथ ही साथ अन्य कृषि कच्चा उत्पादों को भी संस्थागत खरीददारी योजना में शामिल किया गया। खरीददारी के @12 से @32 घंटों (शासकीय अवकाशों को छोड़कर) में भुगतान NEFT/RTGS/अन्य माध्यमों से कृषकों/कृषि उत्पादकों/दुग्ध/दुग्ध उत्पादकों अथवा संस्थागत योजनाओं में शामिल किए गए समस्त औषधीय/अन्य उत्पाद के खाते में ऑनलाइन अंतरण की व्यवस्था सुनिश्चित किए जाने का प्रावधान किया गया। न्यायपंचायत स्तर पर स्थापित किए जाने वाले कृषक सेवा केन्द्रों को तकनीकी माध्यमों से ऑनलाइन निगरानी की व्यवस्था सुनिश्चित किए जाने का प्रावधान किया गया। खरीददारी किए गए समस्त कच्चे उत्पादों के उचित रखरखाव एवं प्रबंधन हेतु संस्थागत चीलिंग/वेयरप्लांट की स्थापना का प्रावधान किया गया। उक्त के क्रम में उत्तर प्रदेश शासन के आदेश संख्या 170/29-5-2018/5(1)/18-टी0 सी0 के क्रम में जिला खाद्य विपणन अधिकारी लखनऊ के पत्रांक 789/आई0 जी0 आर0 एस0/2017 दिनांक 30-10-2017 पर जाँचोपरांत जिला खाद्य विपणन अधिकारी लखनऊ के पत्रांक 01/आई0 जी0 आर0/2018 दिनांक 03-04-2018 के क्रम में श्रीमान आयुक्त खाद्य, श्रीमान अपर मुख्य सचिव/प्रमुख सचिव खाद्य एवं रसद विभाग एवं माननीय मुख्यमंत्री कार्यालय से जारी आई0 जी0 आर0 एस0 संदर्भ संख्या 12157180079853 का अनुमोदन संस्थान को प्राप्त हुआ।

## औषधीय कृषि उत्पाद योजना

उत्तर प्रदेश कृषि विकास संस्थान (वर्तमान प्रचलित/ट्रेड नाम केन्द्रीय कृषि विकास संस्थान) को आयुष इकाई किंग जॉर्ज मेडिकल विश्वविद्यालय उत्तर प्रदेश द्वारा प्रस्तुत किए गए प्रस्ताव पत्रांक 96/KGMU/आयुष-18 दिनांक 18-12-2018 के क्रम में उत्तर प्रदेश द्वारा परीक्षणोपरांत निम्न शर्तों की संस्तुति की गई : उत्तर प्रदेश कृषि विकास संस्थान के पंजीकृत कृषकों द्वारा उत्पादित औषधीय कृषि उत्पादों की खरीददारी प्रस्तावित अटल बिहारी बाजपेयी एडवांस्ड आयुष रिसर्च सेंटर एवं आयुर्वेद पंचकर्म एंड वेलनेस यूनिट अथवा पंचकर्म यूनिट के अनुमोदनोपरांत एवं वित्त की उपलब्धता आदि के तहत भारत सरकार की सहमति से अटल



बिहारी बाजपेयी एडवांस्ड आयुष यूनिवर्सिटी उत्तर प्रदेश द्वारा उत्तर प्रदेश कृषि विकास संस्थान से खरीद की जाएगी जिसका उपयोग असाध्य रोगों के दवा उत्पादन में होगा।

उत्तर प्रदेश संस्थान के पंजीकृत कृषक सदस्यों कर्मचारियों/अधिकारियों के स्वास्थ्य लाभ प्रस्तावित अटल बिहारी बाजपेयी एडवांस्ड आयुष रिसर्च सेंटर एवं आयुर्वेद पंचकर्म एंड वेलनेस यूनिट के अनुमोदनोपरांत एवं वित्त की उपलब्धता आदि के तहत भारत सरकार की सहमति से अटल बिहारी बाजपेयी एडवांस्ड आयुष यूनिवर्सिटी उत्तर प्रदेश द्वारा सुनिश्चित किया जाएगा।

प्रस्तावित अटल बिहारी बाजपेयी एडवांस्ड आयुष रिसर्च सेंटर एवं आयुर्वेद पंचकर्म एंड वेलनेस यूनिट अथवा पंचकर्म यूनिट के अनुमोदनोपरांत एवं वित्त की उपलब्धता आदि के तहत भारत सरकार की सहमति से अटल बिहारी बाजपेयी एडवांस्ड आयुष यूनिवर्सिटी उत्तर प्रदेश की उत्तर प्रदेश कृषि विकास संस्थान द्वारा वित्त की उपलब्धता को सुनिश्चित करना/कराने के क्रम में पर्यवेक्षण, सर्वेक्षण, निरीक्षण, परामर्श आदि का अधिकार केंद्र सरकार के अनुमोदनोपरांत उत्तर प्रदेश कृषि विकास संस्थान को होगा।

प्रस्तावित अटल बिहारी बाजपेयी एडवांस्ड आयुष रिसर्च सेंटर एवं आयुर्वेद पंचकर्म एंड वेलनेस यूनिट अथवा पंचकर्म यूनिट के अनुमोदनोपरांत एवं वित्त की उपलब्धता आदि के तहत भारत सरकार की सहमति से अटल बिहारी बाजपेयी एडवांस्ड आयुष यूनिवर्सिटी उत्तर प्रदेश में राष्ट्र/कृषक/संस्थान/शोध संस्थान/अन्य हितोपयोगी योजनांतर्गत भौगोलिकीय परिवर्तन के क्रम में योजनाओं को परिवर्तनीय होगा।

उत्तर प्रदेश कृषि विकास संस्थान (वर्तमान प्रचलित/ट्रेड नाम केन्द्रीय कृषि विकास संस्थान) एवं आयुष इकाई किंग जॉर्ज मेडिकल यूनिवर्सिटी के बीच उक्त अनुबंध को उत्तर प्रदेश शासन एवं प्रदेश सरकार स्तरीय आदेश संख्या 12157190017652 के माध्यम से स्वीकृति प्राप्त हुई। संस्थान द्वारा कृषकों (पंजीकृत)को प्रति बीघे की दर से 20 हजार रुपये ब्याज रहित शाखीय व्यवस्था के अंतर्गत डेढ़ गुना गारंटी योजना के अंतर्गत औषधीय कृषि उत्पाद योजना के अंतर्गत निःशुल्क प्रशिक्षण प्रदान करते हुए कृषक दो गुना-2022 योजनांतर्गत लाभ (नियमों के अंतर्गत) प्रदान कराया जाएगा। इसके तहत क्रमशः 140 औषधीय पौधों को सम्मिलित कराते हुए आयुष मंत्रालय भारत सरकार द्वारा औषधीय कृषि उत्पाद से संबन्धित फसलों के अंतर्गत अनुबंध/अंशदान/अनुदान आदि औषधीय पौध मिशन के अंतर्गत प्रदान कराया जाएगा। जिसके अंतर्गत माननीय मुख्यमंत्री जी उत्तर प्रदेश को संस्थान द्वारा प्रस्तुत कराये गए प्रस्ताव पर उत्तर प्रदेश शासन के आदेश संख्या -सी0 एम0-53/58-2019-179/2015 दिनांक 16 अप्रैल 2019 के क्रम में निदेशालय के पत्रांक 233/रा0 आ0 मि0/2019-20 दिनांक 24 अप्रैल 2019 के अंतर्गत निदेशालय खाद्य एवं प्रसंस्करण विभाग उत्तर प्रदेश के पत्रांक 76-77 दिनांक 16 अप्रैल 2019 जो माननीय मुख्यमंत्री कार्यालय से अनुमोदित हुआ।

## पशुधन विभाग एवं संस्थागत योजनांतर्गत कार्यवाही

उत्तर प्रदेश कृषि विकास संस्थान (वर्तमान प्रचलित/ट्रेड नाम केन्द्रीय कृषि विकास संस्थान) द्वारा माननीय मुख्यमंत्री जी उत्तर प्रदेश शासन के सम्मुख प्रस्तुत किए गए पशुधन विकास नीति के क्रम में छुट्टा/अन्य गौ वंशीय हितों अथवा पशुओं के संरक्षण/संवर्धन/सुरक्षा/अन्य के क्रम में पशुधन विभाग द्वारा जारी आदेश प्रस्ताव पत्रांक-5840/सा0/मा0 मु0 म0 स0/2017-18 दिनांक 11-02-2019 एवं पूर्व में पशुधन विभाग के आदेश पत्रांक 316/प0-2/22(5)/जनसुनवाई/2018-19 दिनांक 04-07-2018 के क्रम में जनहित उपयोगिता सहित अनापत्ति/स्वीकृति प्राप्त हुई। आदेश संख्या 3709/सैंतीस-2-2018 लखनऊ दिनांक 5 नवम्बर 2018 के माध्यम से उत्तर प्रदेश शासन का आदेश जारी हुआ।

## पर्यावरण विभाग द्वारा कार्यवाही

उत्तर प्रदेश कृषि विकास संस्थान (वर्तमान प्रचलित/ट्रेड नाम केन्द्रीय कृषि विकास संस्थान) द्वारा माननीय मुख्यमंत्री जी उत्तर प्रदेश शासन के सम्मुख प्रस्तुत किए गए कृषि/कृषक अंशीय पर्यावरणीय समस्याओं के निदान हेतु पर्यावरण निदेशालय उत्तर प्रदेश के पत्रांक 345/पर्या0/आई0 जी0 आर0 एस0/2018 दिनांक 29 जून 2018, उत्तर प्रदेश प्रदूषण नियंत्रण बोर्ड के संदर्भ संख्या 3203-4/सी0-6/सा0-66/आई0 जी0 आर0 एस0/20 दिनांक 23-01-2020, पर्यावरण, वन एवं जलवायु परिवर्तन अनुभाग-7 संख्या 214 /81-2019 लखनऊ दिनांक 9 जुलाई 2019 विभागीय कार्यवाही/स्वीकृति/अनापत्ति प्राप्त हुई |

## शैक्षणिक व्यवस्था के अंतर्गत कार्यवाही

उत्तर प्रदेश कृषि विकास संस्थान (वर्तमान प्रचलित/ट्रेड नाम केन्द्रीय कृषि विकास संस्थान) द्वारा माननीय मुख्यमंत्री जी उत्तर प्रदेश शासन के सम्मुख प्रस्तुत किए गए अधिक से अधिक रोजगार (समस्त श्रेणी) सृजन अथवा शत-प्रतिशत भ्रष्टाचार रहित सेवकों का विभिन्न माध्यमों से निर्माण अथवा पद्धति को विकसित किए जाने हेतु अथवा पारदर्शी शैक्षिक/शैक्षणिक/प्रशैक्षणिक/अन्य पद्धतियों को विकसित कर ईमानदार/राष्ट्रहितकारी सेवकों का निर्माण हेतु शॉर्ट/लॉन्ग सर्टिफिकेशन/अन्य कोर्स एवं प्रशिक्षण हेतु उच्च शिक्षा विभाग उत्तर प्रदेश शासन के आदेश संख्या सी0 एम0 212/सत्तर-1-2018 लखनऊ दिनांक 27 दिसम्बर 2018 के क्रम में माननीय मुख्यमंत्री जी स्तरीय अनुमोदन प्राप्त हुआ |

## रोजगार सृजन

प्रायः सरकारी नौकरियों के मामलों में यह पाया गया की सरकारी नौकरी ने आज एक भ्रष्टाचार रूपी व्यवसाय का रूप लेना पाया गया और उसी नौकरी के नाम पर प्रथम श्रेणी से लेकर चतुर्थ श्रेणी तक का रेट (दाम ) तय होना पाया गया | सरकारी नौकरियों में प्रायः योग्य उम्मीदवारों की अनदेखी होने लगी और रिश्वत लेकर अयोग्य उम्मीदवारों का चयन सुनिश्चित किया जाना प्रायः पाया गया | जो अधिकारी/कर्मचारी यदि ईमानदारी करने अथवा कराने की अपेक्षा करने लगा तो ऐसे कर्मचारी/अधिकारी/कर्मचारियों/अधिकारियों की हत्या अथवा फर्जी मुकदमों में फसाना आदि साजिश के शिकार हो जाते हुए पाये गए इसी के संदर्भ में माननीय उच्च न्यायालय इलाहाबाद ने "ईमानदार अधिकारी लुप्तप्राय प्राणी जैसे इनका संरक्षण जरूरी" जैसे कोट किया |

कृषि के स्थान पर भ्रष्टाचार ने एक सहायक उद्योग का दर्जा प्राप्त कर लिया है | ऐसे कृषक कमोवेश ऋण धनराशि सरकार द्वारा माफ कर दिया जाएगा एवं अन्य दिवास्वप्न में पड़कर एक कमजोर कृषक का रूप ले लेता है | ऋण असेट्स के एन0 पी0 ए0 होने से रुपये की मुद्रा स्फीति एक निश्चित सीमा से बढ़ जाती है और रुपया अंतर्राष्ट्रीय बाजारों में कमजोर पड़ने लगता है | एक रिपोर्ट में ऐसा पाया गया है की एक निश्चित समय के बाद ऋणी किसान जो इस आशा में अपना एक अच्छा भविष्य सुरक्षित कर लेता है उसे उचित प्रशिक्षण ना मिलने अथवा उचित ज्ञान ना होने से वह ऋण में प्राप्त किए गए धनराशि की वास्तविक स्थिति से अवगत नहीं होने के कारण ऋण धनराशि का उचित उपयोग नहीं कर पाता है | एक निश्चित अवधि के बाद वह उस धनराशि पर एक निश्चित सीमा से अधिक धनराशि का नोटिस जारी होने पर मानसिक अवसाद में पड़ जाता है और उसे कोई अन्य उपाय दृश्यात्मक ना होने पर आत्महत्या जैसा कुत्सित कर्म करने पर बाध्य हो जाता है | कृषि क्षेत्र में प्रायः यह पाया गया कि कृषकों द्वारा इस तरह कृषि कार्य एक निष्प्रयोज्य कार्य लगने लगा और युवा शक्ति (ग्रामीण) एक निश्चित सीमा से अधिक ग्रामीण से शहरों की ओर पलायन करने लगे जिससे शहरों पर एक निश्चित सीमा से अधिक बोझ बढ़ा एवं एक निश्चित सीमा से अधिक बेरोजगारी बढ़ने लगी जबकि कृषि को उद्योग जैसे स्वरूप अथवा उद्योग के रूप में वृहद स्तर पर रोजगार का सृजन किया जा सकता है | प्रायः यह पाया गया कि कृषकों द्वारा उत्पादित कच्चे उत्पादों की खरीददारी हेतु उनके लिए उचित खरीद बाजार अन्य व्यवस्था का उचित प्रबंध भारत राष्ट्र को आज्ञादी के इतने वर्षों बाद भी नहीं उपलब्ध कराया जा सका जिससे हम केवल 2% से 10% (दो से दस प्रतिशत) ही अंतर्राष्ट्रीय बाजारों में भौतिक रूप

से अपनी (भारतवर्ष के प्रतिनिधित्व) उपस्थिति (वास्तविक) दर्ज़ करने में सफल हुए जबकि यह शासकीय अथवा भारत राष्ट्र के योग्य एवं कुशल अभ्यर्थी का उचित उपयोग न कर पाने की अकुशलता है।

उत्तर प्रदेश कृषि विकास संस्थान (वर्तमान प्रचलित/ट्रेड नाम केन्द्रीय कृषि विकास संस्थान) द्वारा प्रस्ताव पत्रांक 162/उ० प्र० कृ० वि० सं०/लखनऊ/2018-19 दिनांक 03-10-2018 को माननीय श्रम एवं रोजगार मंत्री भारत सरकार नई दिल्ली के सम्मुख संस्थान द्वारा स्वीकृत 1.5 लाख (डेढ़ लाख) विभिन्न संविदा/अन्य पदों के क्रम में उत्तर प्रदेश शासन के आदेश संख्या 1204/36-3-2018-89(सा०)/2018 दिनांक 17 जुलाई 2018 एवं आदेश संख्या 1435 /36-3-2018-89(सा०)/2018 दिनांक 27 अगस्त 2018 के क्रम में समस्त विभागीय कार्यवाही पूर्ण कराते हुए स्वीकृति प्राप्त हुई।

## बजट स्वीकृति

उत्तर प्रदेश कृषि विकास संस्थान (वर्तमान प्रचलित/ट्रेड नाम केन्द्रीय कृषि विकास संस्थान) द्वारा प्रस्तुत किए गए राज्य/राष्ट्र स्तरीय प्रस्ताव को राज्य स्तरीय अनापत्ति/संबद्धता/स्वीकृति(बजट/अन्य) के क्रम में माननीय प्रधानमंत्री जी भारत सरकार एवं माननीय अध्यक्ष नीति आयोग को प्रस्तुत किए गए वित्तीय वर्ष 2018-19 से 2022-23 हेतु प्रस्तुत किए गए क्रमशः संस्थागत इकाइयों के संचालन हेतु वार्षिक व्यय 4527 करोड़ (चार हज़ार पाँच सौ सत्ताईस करोड़), मानव संसाधन हेतु क्रमशः 349 करोड़ (तीन सौ उन्चास करोड़), दुग्ध मशीनरी पर व्यय हेतु 186 करोड़ (एक सौ छियासी करोड़), धान मिल पर व्यय हेतु 100 करोड़ (सौ करोड़), भूमि एवं निर्माण कार्य पर व्यय हेतु 6680 करोड़ (छः हज़ार छः सौ अस्सी करोड़), वाहन खरीद पर व्यय हेतु 89.80 करोड़ (नवासी करोड़ अस्सी लाख) कुल 11931.80 करोड़ (ग्यारह हज़ार नौ सौ इकतीस करोड़ अस्सी लाख मात्र) बजट मांग प्रस्ताव पर माननीय प्रधानमंत्री कार्यालय संदर्भ संख्या पी० एम० ओ० पी० जी०/डी०/2018/0296165 दिनांक 17-08-2018 के क्रम में कृषि एवं किसान कल्याण मंत्रालय के पशुधन, दुग्ध एवं मत्स्य विभाग के आदेश फ़ाइल संख्या 17-1/2018-डी० पी० दिनांक 19 सितम्बर 2018 द्वारा संस्थागत प्रस्तुत किए गए बजट मांग प्रस्ताव को श्रीमान संयुक्त सचिव कृषि एवं किसान कल्याण मंत्रालय द्वारा अनुमोदन/स्वीकृति प्राप्त हुआ।

उत्तर प्रदेश कृषि विकास संस्थान (वर्तमान प्रचलित/ट्रेड नाम केन्द्रीय कृषि विकास संस्थान) द्वारा संस्थागत 5529 विभिन्न संविदा पदों के राज्य स्तरीय परीक्षा कराये जाने बावत माननीय मुख्यमंत्री जी के कार्यालय से जारी आदेश के क्रम में जिला विद्यालय निरीक्षक लखनऊ के आदेश पत्रांक वाह्य परीक्षा/322-23/2019-20 दिनांक 10 अप्रैल 2019, जिला मैजिस्ट्रेट लखनऊ द्वारा जारी 299/मुंसरिम/2019 दिनांक 11 अप्रैल 2019 जो दो विद्यालयों क्रमशः राजकीय हुसैनाबाद इंटर कॉलेज लखनऊ एवं अमीनाबाद इंटर कॉलेज लखनऊ द्वारा कृषि विभाग के अंतर्गत आख्या प्राप्त हुई। श्रीमान जिला मैजिस्ट्रेट लखनऊ, जिला विद्यालय निरीक्षक लखनऊ, वरिष्ठ पुलिस अधीक्षक लखनऊ, पुलिस अधीक्षक(प्रोटोकॉल) लखनऊ, प्रधानाचार्यों क्रमशः राजकीय हुसैनाबाद इंटर कॉलेज लखनऊ एवं अमीनाबाद इंटर कॉलेज लखनऊ के कुशल देखरेख में दिनांक 28 अप्रैल 2019 को शत-प्रतिशत नकलविहीन परीक्षा कुशलता पूर्वक सम्पन्न कराया गया।

उत्तर प्रदेश कृषि विकास संस्थान (वर्तमान प्रचलित/ट्रेड नाम केन्द्रीय कृषि विकास संस्थान) का सम्पूर्ण योजनाएँ/कार्ययोजनाएँ/अन्य राष्ट्र स्तरीय परिधि में होने के कारण उत्तर प्रदेश कृषि विकास संस्थान द्वारा वस्तु एवं सेवा कर को प्रस्तुत किए गए पत्रांक - ००७/ के०कृ०वि०सं०/के०आ०(उ० वि०)/ २०१९-२० दिनांक १२/०६/२०१९ के क्रम में उत्तर प्रदेश कृषि विकास संस्थान का ट्रेड नाम भारत सरकार के अनुमोदनोपरांत केन्द्रीय कृषि विकास संस्थान संशोधित करते हुए संस्थान द्वारा प्रस्तुत किये गए विभिन्न प्रस्ताव की संस्तुति/स्वीकृति के क्रम में भारत राष्ट्र को अंतर्राष्ट्रीय स्तर पर विकसित राष्ट्र स्थापित होने के/तक कृषि /कृषकों के अंश उद्देश्यों हेतु भारत सरकार द्वारा स्वायत्तता प्राप्त संस्थान के रूप में कृषि/कृषकों अथवा संस्थान के निहित उद्देश्यों की पूर्ति/सम्पूर्ति हेतु स्वतंत्र केन्द्रीय एजेंसी के रूप में स्थायी रूप से कार्य करेगी, का अनुमोदन प्राप्त हुआ।

केन्द्रीय कृषि विकास संस्थान (संशोधन पूर्व प्रचलित/ट्रेड नाम उत्तर प्रदेश कृषि विकास संस्थान) द्वारा संस्थान के केन्द्रीय मुख्यालय की स्थापना हेतु श्रीमान कृषि सचिव भारत सरकार के आदेश डायरी संख्या 472175 दिनांक 17-01-2020 के माध्यम से भारतीय कृषि अनुसंधान परिषद कृषि भवन नई दिल्ली द्वारा जारी डायरी संख्या 366924/स 0 म 0(त 0 स 0) दिनांक 23-03-2020 द्वारा केन्द्रीय मुख्यालय की NCR में खरीददारी हेतु वाणिज्य मंत्रालय को वित्त उपलब्ध कराये जाने बावत संस्थागत कार्यवाही कराई गई।

केन्द्रीय कृषि विकास संस्थान (संशोधन पूर्व प्रचलित/ट्रेड नाम उत्तर प्रदेश कृषि विकास संस्थान) द्वारा श्रीमान कृषि सचिव भारत सरकार नई दिल्ली को बजट उपलब्ध कराये जाने बावत दिनांक 20-08-2019 को प्रस्तुत किए प्रस्ताव पर जारी आदेश डायरी संख्या 438536 दिनांक 29-08-2019 के क्रम में खाद्य प्रसंस्करण उद्योग मंत्रालय भारत सरकार नई दिल्ली के आदेश फ़ाइल संख्या 12033/69/2019-पी 0 सी 0 दिनांक 07-11-2019 को आदेश जारी हुआ तत्क्रम में संस्थान द्वारा खाद्य प्रसंस्करण उद्योग मंत्रालय भारत सरकार नई दिल्ली के विभिन्न बैठकों में संस्थागत अंतर्राष्ट्रीय स्तरीय 01(एक) उच्च स्वचालित मेगा फूड पार्क की स्थापना का प्रावधान किया गया।

केन्द्रीय कृषि विकास संस्थान (संशोधन पूर्व प्रचलित/ट्रेड नाम उत्तर प्रदेश कृषि विकास संस्थान) द्वारा माननीय सूचना एवं प्रसारण मंत्री भारत सरकार नई दिल्ली को संस्थान के पत्रांक 06/के 0 कृ 0 वि 0 सं 0/2020-21 दिनांक 03-02-2020 के तहत संस्थान को राष्ट्रीय सूचना केंद्र द्वारा आधिकारिक सामूहिक मेल एवं वेबसाइट उपलब्ध कराये जाने बावत प्रस्ताव पर मंत्रालय के डायरी संख्या 451914 दिनांक 13-02-2020 के क्रम में मंत्रालय से महानिदेशक राष्ट्रीय सूचना केंद्र को जारी आदेश संख्या 10(16)/2018-EG-II दिनांक 26-002-2020 के क्रम में संस्थान को शासकीय ईमेल आईडी [director@cagdi.in](mailto:director@cagdi.in) प्राप्त हुआ।

केन्द्रीय कृषि विकास संस्थान (संशोधन पूर्व प्रचलित/ट्रेड नाम उत्तर प्रदेश कृषि विकास संस्थान) द्वारा कोरोना काल के दौरान 2167 विभिन्न पदों पर साक्षात्कार माध्यम से नियुक्ति हेतु निःशुल्क आवेदन ईमेल माध्यम से आमंत्रित किए गए। तत्क्रम संस्थान को श्रम एवं रोजगार मंत्रालय द्वारा स्वायत्तता प्राप्त सार्वजनिक क्षेत्रीय उद्यम के रूप में अनुमोदन प्राप्त हुआ। तत्क्रम में राष्ट्रीय कैरियर सेवा श्रम एवं रोजगार मंत्रालय द्वारा जॉब आईडी 15V79-1357159302290J द्वारा 2167 पदों की स्वीकृति प्रदान हुई।

केन्द्रीय कृषि विकास संस्थान (संशोधन पूर्व प्रचलित/ट्रेड नाम उत्तर प्रदेश कृषि विकास संस्थान) द्वारा श्रीमान निजी/प्रमुख सचिव भारत सरकार नई दिल्ली को दिनांक 15 अप्रैल 2020 को संस्थान द्वारा प्रस्तुत किए गए प्रस्ताव पर माननीय प्रधानमंत्री कार्यालय से जारी आदेश संख्या पी 0 एम 0 ओ 0 पी 0 जी 0/डी 0/2020/0101494 दिनांक 20 मई 2020 में संस्थान को अधीनस्थ संगठन के रूप में चिन्हित किया गया।

उपरोक्त संस्थागत आंशिक इतिहास प्रस्तुत किया जा रहा है, एवं अन्य शोध/कार्यवाही प्रचलन में हैं। समस्त शोध/जांच/कार्यवाही में विभिन्न उच्चस्तरीय/अन्य शासकीय/अन्य अधिकारियों/कर्मचारियों/अन्य के सहयोग/स्वीकृतियां/अनापत्ति/अन्य अथवा मंत्रालयीय/विभागीय सहयोग/स्वीकृति/अनापत्ति/अन्य प्राप्त हुई। केन्द्रीय कृषि विकास संस्थान (संशोधन पूर्व प्रचलित/ट्रेड नाम उत्तर प्रदेश कृषि विकास संस्थान) माननीय प्रधानमंत्री जी भारत सरकार नई दिल्ली एवं माननीय मुख्यमंत्री जी उत्तर प्रदेश शासन लखनऊ के संरक्षण में अथवा आदेशानुसार/निर्देशानुसार/अपेक्षानुसार भारत राष्ट्र को अंतर्राष्ट्रीय स्तर पर विकसित राष्ट्र स्थापित होने तक/के कृषि/कृषकों के अंश उद्देश्यों हेतु भारत सरकार द्वारा स्वायत्तता प्राप्त संस्थान के रूप में कृषि/कृषकों अथवा संस्थान के निहित उद्देश्यों की पूर्ति/संपूर्ति हेतु ज़ीरो टॉलरेंस अथवा ज़ीरो करप्शन बेस्ड पॉलिसी (ज़ेड 0 सी 0 बी 0 पी 0) के क्रम में संस्थान स्वतंत्र केन्द्रीय एजेंसी के रूप में स्थायी रूप से कार्य कर रही है अथवा स्वायत्तता प्राप्त केन्द्रीय सार्वजनिक क्षेत्रीय उद्यम के रूप में भारत सरकार द्वारा अनुमोदित है। इसके साथ ही साथ संस्थान द्वारा विभिन्न विभागीय/अन्य शासकीय/अशासकीय कार्यवाही प्रचलित है। जनहितार्थ सूचनाएँ समय-समय पर सर्व साधारण हेतु

विभिन्न माध्यमों से सुलभ उपलब्ध कराई जाती रहेंगी | संस्थान द्वारा घोषित निवेश/योजनाएँ अथवा अन्य के क्रम में निवेश/निवेशक हितलाभ, रोजगार हितलाभ अथवा अन्य समस्त तथ्यों में निहित हितलाभ पर संस्थान प्रतिबद्ध/वचनबद्ध है |

## केन्द्रीय कार्यालय/मुख्यालय हेतु महत्वपूर्ण सूचना

सर्वसाधारण को सूचित किया जाता है कि केन्द्रीय कृषि विकास संस्थान द्वारा निजी केन्द्रीय कार्यालय/मुख्यालय की स्थापना हेतु दिनांक 17 जनवरी 2020 में श्रीमान कृषि सचिव भारत सरकार नई दिल्ली के सम्मुख प्रस्तुत किये गए खरीद प्रस्ताव पर जारी आदेश डायरी संख्या 472175 दिनांक 17 जनवरी 2020 के तहत केन्द्रीय कृषि विकास संस्थान से जारी प्रस्ताव पत्रांक 43/के.कृ.वि.सं./2019-20 दिनांक 20 जनवरी 2020 के क्रम में श्रीमान सहायक महानिदेशक भारतीय कृषि अनुसंधान परिषद् स्तरीय जारी स्वीकृति/सुझाव आदेश पत्र संख्या 366924/स.म.(त.स.) दिनांक 23.03.2020 तत्क्रम श्रीमान कृषि सचिव भारत सरकार नई दिल्ली 106/के.कृ.वि.सं./2019-20 दिनांक 26 फरवरी 2020 को खरीद कार्यवाही विषयक आख्या/प्रस्ताव/रिपोर्ट अथवा संस्थागत स्वीकृति प्रदान की गयी। मा.मुख्यमन्त्री जी उ.प्र.शासन को केन्द्रीय कार्यालय/मुख्यालय की स्थापना हेतु खरीद प्रस्ताव पर जारी आदेश संख्या CRCD000732687864 दिनांक 30 जनवरी 2020 के क्रम में ग्रेटर नोएडा विकास प्राधिकरण के आदेश पत्रांक-ग्रे.नो./संस्थागत/2020/995 दिनांक 04.02.2020 कार्यवाही सम्पूर्ण करायी जा चुकी है। तत्क्रम केन्द्रीय कार्यालय/मुख्यालय का एन.सी.आर.के ग्रेटर नोएडा में स्थापना प्रस्तावित |



CAGDI

Central Agricultural Development Institution

Kendriya Krishi Vikas Sansthan

(An Autonomous Body Undertaking By  
Government Of India As “Central Agency”)



# Goals

Central Agricultural Development Institution (CAGDI) aims to doubling or other increased income of Indian Farmers and boosting Indian Economy Growth or GDP on Global scale, with actual implementation of Central/ State Governments and CAGDI Schemes or Joint schemes, for Farmers and Skilled/Semi-skilled/Non-skilled Labours of India.



# CAGDI Research Briefing

The following facts/reports came to light in view of corruption in physical / other forms of share of agriculture / farmers:

- Bank loan problem is often the root factor of farmer suicides.
- The basic reason for rural migration is the lack of accessible agriculture/other system at the village level.
- Continuous shortage of employment (national/state level) in the departmental/agricultural sector despite the immense possibilities of employment (government jobs and rural employment).
- Livestock system which may be physically involved in the allied arrangements of agriculture, not to be included in actual or non-compliance of policies.
- There is no laxity in the rules against corruption for the general public but for the government officials to relax the rules.
- If caught taking a bribe, then taking a bribe, taking an exemption etc. was seen in the system (government system).
- Often the agency of physical supervision of the actual implementation of the schemes released by the Central/State Government, etc., was not seen to work on the actual ground.
- The lack of physical verification of the actual implementation of schemes/projects/policies/mandates/others issued by the Central/State Government was reflected.





# Types of Logins in ERP

CAGDI ERP has following types of users logins:

- Administration (9 Series)
- Government (Central/State) (7 Series)
- Employee (1 Series)
- Farmer (2 Series)
- Investor (3 Series)
- Accounts Department (4 Series)
- Beneficiary (5 Series)
- Guest/Auditor (6 Series)

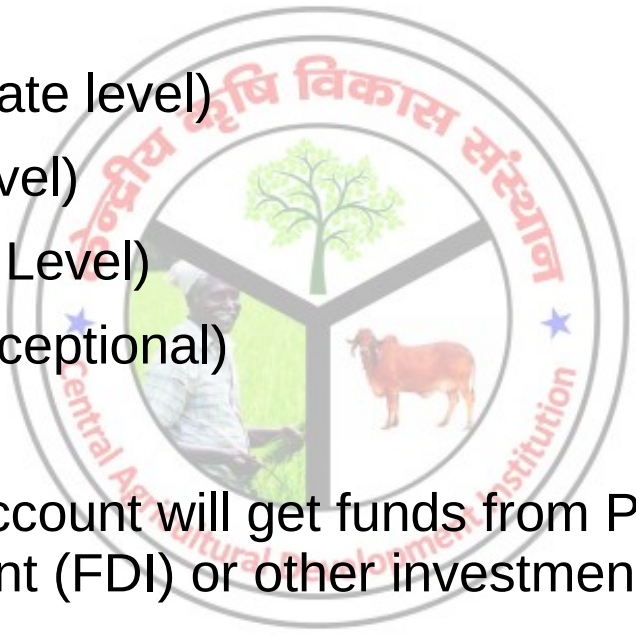

# Type of Debit/Credit Accounts

- Central Head Quarter Account
  - Foreign Account
  - Head Office Account (State level)
  - Zonal Account (Zone Level)
  - District Account (District Level)
  - Local/Other Account (exceptional)
- 
- Central Head Quarter Account will get funds from Public Investment (PI) and Foreign Direct Investment (FDI) or other investment from changeable features.
  - Central Head Quarter Account will get budget from central/state government or governments and/or other government level funds.



# Special Features

- MSP purchasing of Agriculture yields in state /states at Nyay Panchayats.
- Grading system for Beneficiary (Migrant/Other Labours “Skilled/Semi-Skilled/Non-Skilled”)
- Purchasing of Medicinal Agricultural yield/yields in state/states at Nyay Panchayats.
- Doubling income of agriculturists by various Central/State Governments or Institution or Joint Schemes.



# Processes for Farmer

- Farmer Registration
- Farmer Listing for various Government sponsored schemes
  - (i) DEEDS
  - (ii) MSP
  - (iii) MAPS
  - (iv) Grade Scheme
- Farmer Registration includes aadhar and bank details conforming to schemes for DBT/Other or Subsidy and Other based.



# Krishak Sewa Kendra/Mini Collection Center at Nyay Panchayat

## Farmer Registration for Purchase

- Agri Raw Material on MSP And Other Prices.
- Dairy Product Purchase or Milk Purchase on special prices declared by Institution at time to time.
- Purchase for Medicinal Agri Raw/Other Product.
- Purchase for fruits and vegetables.

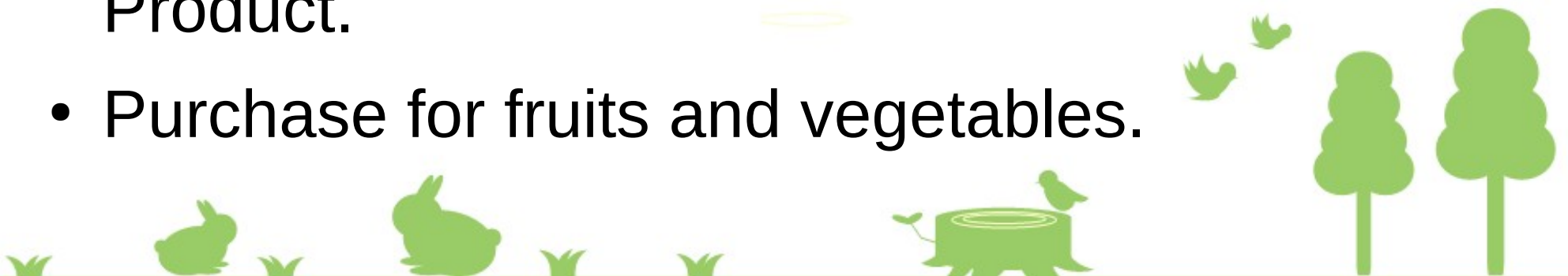

# Krishak Sewa Kendra/Mini Collection Center at Nyay Panchayat

Technologies for Purchase/Sales or Mandi in Marketing/Sales/Other Unit

- The procurement of all category of Agri produce taken care/carried/purchased by cyber physical technologies using Indigenous/Other equipments and methods.
- Purchase program (All Category) controll/command by online surveillance using Indigenous/Other equipments and methods.

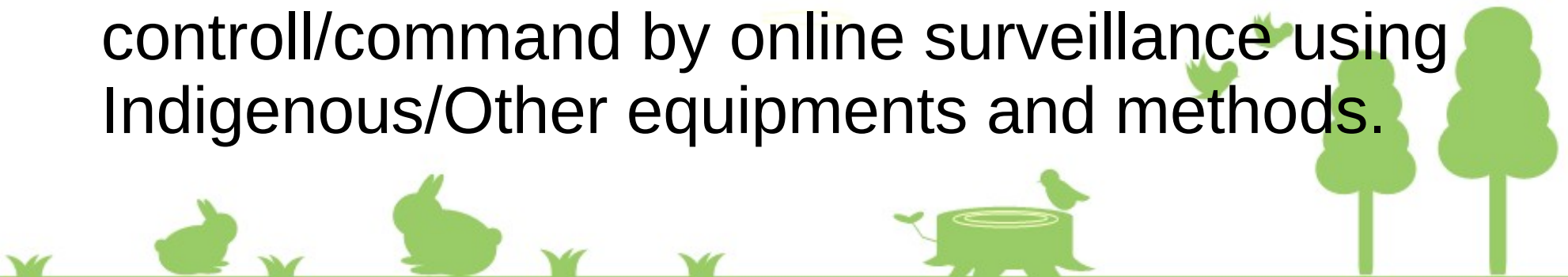

## Dairy Entrepreneurship Development Scheme Chart

S.N.	COMPONENT	INDICATIVE UNIT COST	PATTERN OF ASSISTANCE
01	Establishment of small dairy units with crossbred cows/indigenous descript milch cows like Sahiwal, Rathi, Red Sindhi, Gir etc/graded buffaloes upto 10 animals. (for SHGs Cooperatives societies, Producer Companies unit size will be 2-10 animals per member)	Rs.7.00 lakh for 10 animal unit. Minimum unit size is 2 animals with an upper limit of 10 animals.	25% of the project cost(33.33% for SC/ST farmers), as back ended capital subsidy. Subsidy shall be restricted on prorata basis to a maximum of 10 animals subject to a ceiling of Rs. 17500 per animal,(Rs.23300 for SC/ST farmers)
02	Rearing of heifer calves-cross bred,indigenous descript milch breeds of cattle and of graded buffaloes-upto 20 calves	Rs. 9.70 lakh for 20 calf unit- with an upper limit of 20 calves	25% of the project cost (33.33% for SC/ST farmers) as back ended capital subsidy. Subsidy shall be restricted on portata basis to a maximum of 20 calf unit subject to ceiling of Rs. 12,100/- per calf(Rs. 16,200 for SC/ST farmers) or actual whichever is lower.

## Dairy Entrepreneurship Development Scheme Chart

03	Vermi compost with milch animal unit (to be considered with milch animals/small dairy farm and not separately)	Rs. 25,200/-	25% of the project cost (33.33% for SC/ST farmers) as back ended capital subsidy subject to ceiling of Rs. 6,300/- (Rs8400/- for SC/ST farmers) or actual whichever is lower.
04	Purchase of milking machines/milkotesters/bulk milk cooling units (upto 5000 lit capacity)	Rs. 20 lakh	25% of the project cost (33.33% for SC/ST farmers) as back ended capital subsidy subject to ceiling of Rs.5.0 lakh (Rs. 6.67 lakh for SC/ST farmers) or actual whichever is lower.





## Dairy Entrepreneurship Development Scheme Chart

05	Purchase of dairy processing equipment for manufacture of indigenous milk products	Rs. 13.20 lakh	25% of the project cost (33.33% for SC/ST farmers) as back ended capital subsidy subject to ceiling of Rs.3.30 lakh (Rs. 4.40 lakh for SC/ST farmers) or actual whichever is lower.
06	Establishment of dairy product transportation facilities and cold chain	Rs. 26.50	25% of the project cost (33.33% for SC/ST farmers) as back ended capital subsidy subject to ceiling of Rs.6.625 lakh (Rs. 8.830 lakh for SC/ST farmers) or actual whichever is lower.



## Dairy Entrepreneurship Development Scheme Chart

07	Cold storage facilities for milk and milk products	Rs. 33 lakh	25% of the project cost (33.33% for SC/ST farmers) as back ended capital subsidy subject to ceiling of Rs.8.25 lakh (Rs. 11.0 lakh for SC/ST farmers) or actual whichever is lower.
08	Establishment of private veterinary clinics	Rs. 2.60 lakh (mobile)& Rs. 2.0 lakh (stationary)	25% of the project cost (33.33% for SC/ST farmers) as back ended capital subsidy subject to ceiling of Rs.65000/- and Rs. 50000/- (Rs. 86,600/- and Rs. 66,600/- for SC/ST farmers) respectively for mobile and stationary clinics or actual whichever is lower.
09	Dairy marketing outlet/Dairy parlour	Rs. 3 lakh	25% of the project cost (33.33% for SC/ST farmers) as back ended capital subsidy subject to ceiling of Rs. 75,000 (Rs. 1,00,000/- for SC/ST farmers) or actual whichever is lower.

# Dairy Entrepreneurship Development Scheme Chart



## Note:-

The subsidy amount will be rounded off to the nearest 100 Rupees. Beneficiaries may submit project proposals without any limit. However, the back ended capital subsidy under the scheme will be restricted to the above ceilings. The Banks will verify the cost of components admissible under the scheme based on the cost norms notified by NABARD.



# NATIONAL AYUSH MISSION (NAM) LIST OF PRIORITIZED PLANTS FOR CULTIVATION UNDER SCHEME OF NMPB

Plants Eligible for 75% Subsidy		
S.N.	Botanical Name	Common Name
1	<i>Aconitum ferox</i> Wall. / <i>Aconitum balfourii</i> Stapf.	Vatsnabh
2	<i>Aconitum heterophyllum</i> Wall. ex Royle	Atees
3	<i>Aquilaria agallocha</i> Roxb.	Agar
4	<i>Berberis aristata</i> DC.	Daruhaldi
5	<i>Commiphora wightii</i> (Arn.) Bhandar	Guggal
6	<i>Nardostachys jatamansi</i> DC.	Jatamansi
7	<i>Oroxylum indicum</i> Vent.	Syonaka
8	<i>Picrorhiza kurroa</i> Benth. ex Royle	Kutki
9	<i>Podophyllum hexandrum</i> (Royle) T.S. Ying)	Bankakri, Indian podophyllum
10	<i>Pterocarpus santalinus</i> Linn. f.	Raktachandan, Red sanders
11	<i>Santalum album</i> Linn.	Chandan
12	<i>Saussurea costus</i> C.B. Clarke	Kuth, Kustha
13	<i>Swertia chirata</i> Buch-Ham	Chirata, Charayatah

# NATIONAL AYUSH MISSION (NAM) LIST OF PRIORITIZED PLANTS FOR CULTIVATION UNDER SCHEME OF NMPB

## Plants Eligible for 30% Subsidy

S.N.	Botanical Name	Common Name
1	Abrus precatorius Linn	Chirmati, Chinnoti, Gudumani
2	Acorus calamus Linn.	Vach
3	Adhatoda zeylanica Linn.	Adusa
4	Aloe vera (Linn.) Burn.	Ghritkumari
5	Alpinia calcarata Roxb.	Smaller Galangal
6	Alpinia galanga (Linn.) Willd.	Greater Galanga
7	Andrographis paniculata (Linn.) Burn	Kalmegh
8	Artemisia annua Linn.	Artemisia
9	Asparagus racemosus Willd.	Shatavari
10	Azadirachta indica A. Juss	Neem
11	Bacopa monnieri (L.) Pennell	Brahmi
12	Bergenia ciliata Stern.	Pashnabheda
13	Boerhaavia diffusa Linn.	Punarnava

# NATIONAL AYUSH MISSION (NAM) LIST OF PRIORITIZED PLANTS FOR CULTIVATION UNDER SCHEME OF NMPB

## Plants Eligible for 30% Subsidy

S.N.	Botanical Name	Common Name
14	<i>Cassia angustifolia</i> Vahl.	Senna
15	<i>Caesalpinia sappan</i> Linn.	Patang
16	<i>Catharanthus roseus</i> (Linn.) G. Don	Sadabahar
17	<i>Celastrus paniculatus</i> Willd.	Malkangani, Jyothismathi, BavanthiBeeja
18	<i>Centella asiatica</i> (Linn.) Urban	Mandookparni
19	<i>Chlorophytum borivillianum</i> Sant.	ShwetMusali
20	<i>Cinnamomum verum</i> Presl	Dalchini
21	<i>Cinnamomum tamala</i> (Buch.- Ham.) Nees et Eberm.	Tejpat
22	<i>Cinnamomum camphora</i> (Linn.) J.Presl.	Kapoor
23	<i>Clerodendrum phlomoidis</i> Linn.f	Arni
24	<i>Clitoria ternatea</i> Linn. (Blue & White variety)	Aparajita
25	<i>Coleus barbatus</i> Benth.	PatherChur
26	<i>Convolvulus microphyllus</i> Sieb. exSpreng.	Shankpushpi

# NATIONAL AYUSH MISSION (NAM) LIST OF PRIORITIZED PLANTS FOR CULTIVATION UNDER SCHEME OF NMPB

## Plants Eligible for 30% Subsidy

S.N.	Botanical Name	Common Name
27	<i>Cryptolepis buchanani</i> Roem&schult	Krsnasariva
28	<i>Dioscorea bulbifera</i> Linn.	Rotalu, Gethi
29	<i>Eclipta alba</i> Hassk.	Kesuria, Bhangru, Bhangra, Kesuti, Ajagara, Bringaraj, Kesar raja, Sumilaka, Suparna, Weed yam
30	<i>Embelia ribes</i> Burm. f.	VaiVidang
31	<i>Emblica officinalis</i> Gaertn.	Amla
32	<i>Garcinia indica</i> Choisy	Kokum
33	<i>Gymnema sylvestre</i> R. Br.	Gudmar
34	<i>Hedychium spicatum</i> Buch-Ham. ex Smuth	Kapurkachari
35	<i>Hemidesmus indicus</i> R.Br.	Anantmool, Indian Sarsaparilla
36	<i>Holarrhena antidysenterica</i> Wall.	Kurchi/Kutaj
37	<i>Ipomoea turpethum</i> R. Br.	Trivrit
38	<i>Kaempferia galanga</i> Linn.	Indian crocus
39	<i>Lepidum sativum</i> Linn.	Chandrasur

# NATIONAL AYUSH MISSION (NAM) LIST OF PRIORITIZED PLANTS FOR CULTIVATION UNDER SCHEME OF NMPB

Plants Eligible for 30% Subsidy		
S.N.	Botanical Name	Common Name
40	<i>Mucuna prurita</i> Linn.	Konch
41	<i>Ocimum sanctum</i> Linn.	Tulsi
42	<i>Phyllanthus amarus</i> Schum&Thonn.	Bhumiamlaki
43	<i>Piper longum</i> Linn.	Pippali
44	<i>Plantago ovata</i> Forssk.	Isabgol
45	<i>Psoralea corylifolia</i> Linn.	Bakuchi
46	<i>Rubia cordifolia</i> Linn.	Manjishtha
47	<i>Sida cordifolia</i> Linn.	Flannel weed
48	<i>Solanum anguivi</i> Lam	Katheli-badhi
49	<i>Solanum nigrum</i> Linn.	Makoy
50	<i>Stevia rebaudiana</i> (Bert.) Bertoni	Madhukari
51	<i>Tephrosia purpurea</i> Pers	Pawad, Dhamasia, Kalika, Plihari, Sharapunkha, Purple Tephrosia, Wild Indigo, Empali
52	<i>Terminalia arjuna</i> (Roxb.) Wt. & Arn.	Arjuna
53	<i>Terminalia bellirica</i> Gaertn	Behera
54	<i>Terminalia chebula</i> Retz.	Harad
55	<i>Tinospora cordifolia</i> Miers	Giloe
56	<i>Vitex nigundo</i> Linn.	Nirgundi
57	<i>Withania somnifera</i> (Linn.) Dunal	Ashwagandha



# NATIONAL AYUSH MISSION (NAM) LIST OF PRIORITIZED PLANTS FOR CULTIVATION UNDER SCHEME OF NMPB

Plants Eligible for 50% Subsidy

S. N.	Botanical Name	Common Name
1	Acacia catechu Willd.	Katha
2	Aegle marmelos (Linn) Corr.	Beal
3	Albizzia lebbek Benth.	Shirish
4	Alstonia scholaris R.Br	Satvin, Saptaparna
5	Atropa belledona Linn.	Atropa
6	Crataeva nurvala Buch – Ham.	Varun
7	Desmodium gangeticum (Linn.) DC.	Sarivan
8	Gloriosa superb Linn.	Kalihari
9	Glycyrrhiza glabra Linn.	Licorice Roots, Mulethi
10	Gmelina arborea Linn.	Gambhari
11	Hippophae rhamnoides Linn.	Seabuckthorn
12	Inula racemosa Hk. f.	Pushkarmool
13	Leptadenia reticulate (Retz) Wt. & Arn.	Jivanti

Plants Eligible for 50% Subsidy

S. N.	Botanical Name	Common Name
14	Mesua ferrea Linn.	Nagakeshar
15	Plumbago zeylanica Linn.	Chitrak
16	Pueraria tuberosa DC.	Vidarikand
17	Premna integrifolia Linn.	Agnimanth
18	Pterocarpus marsupium Roxb.	Beejasar
19	Rauwolfia serpentina Benth. ex Kurz	Sarpgandha
20	Rheum emodi Wall.	Archa
21	Saraca asoca (Roxb.) De Wilde	Ashok
22	Smilax china Linn.	Hrddhatri (Madhu snuhi), Chob Chini Lokhandi
23	Stereospermum suaveolens DC.	Patala
24	Tacomella undulata (Sm.) Seem.	Rohitak
25	Urarea picta (Jacq.) Desv.	Prishnaparni
26	Valeriana wallichii DC.	Indian Valerian
27	Zanthoxylum alatum Roxb.	Timoor

# Investment Policies

- 1) There is provision for Indians to invest in Agriculture and Allied Sector like D.E.D.S. (Dairy Entrepreneurship Development Scheme) and Others.
- 2) There is possibility of secured investment in procurement of Wheat/Paddy/Vegetables And Others Agricultural Raw/Other Product/Materials (All Category) under M.S./O.P. (Minimum Support/Other Price) Scheme. There is provision for Indians to invest in proposed procurement under G.P.S. based C.C.T.V. surveillance at Nyay Panchayat level Krishak Sewa Kendra/Mini Collection Center/Milk Collection Center and Others.
- 3) There is provision for Indians for secured investment in Fertilizers (Bio and Chemical) Seeds, Agriculture Equipments etc.
- 4) There is provision for investment from Indians in the loan given to Financial assistance by the Kendriya Krishi Vikas Sansthan (CAGDI) Financial Joint Venture and Others for registered Skilled/Semi-Skilled/Non-Skilled Labours and Farmers Or Both (All Category) by Department/Division/SubDivision/Other listed Farmers as per CAGDI Schemes/Projects/Policy.



# Investment Policies

- 5) There is provision of investment for Indians in setting up a High Quality Automatic Mega Food Park in any one state of Republic of India.
- 6) There is provision of investment for Indians in Institutional Agri Product processing unit, Financial/Banking Institutional(Training/Educational/Services) Unit, Cow Shelter (Gaushala) for stray animals (Cow/Others), Insurance(Training/Educational/Services) Unit, Agri Instruments(Training/Educational/Manufacturing/Services) Unit, Bio/Chemical Fertilizer(Training/Educational/Manufacturing/Services) Unit, Research(Hybridization for Agriproduct, Hybridization for Cow, Hybridization for Bio etc.) Unit, Controlled Price Stall/ Unit, Cold Storage/Milk Cold Storage/Dairy Product Processing Unit at Zonal/Other Level under Institutional Industrial Unit in Republic of India.
- 7) There is provision of investment in all expenses proposed for setting up Human Resources in Sales/Marketing Unit in India and Foreign units of Kendriya Krishi Vikas Sansthan.
- 8) There is 8% interest with Quaterly Compound Interest Gauranteed for Indians on all categories of investment in Kendriya Krishi Vikas Sansthan.



# Investment Policies

- 9) There might be different interest rates for N.R.I. in Investment Policy of Kendriya Krishi Vikas Sansthan.
- 10) There is provision of Foreign Direct Investment in All Schemes/Projects/Policies(All Category) of Kendriya Krishi Vikas Sansthan. In F.D.I., the rate of interest will be based on Memorandum of Understanding (M.O.U.) between Institution and Foreign Investor/Investers(Except China).
- 11) The Investment Policy of Kendriya Krishi Vikas Sansthan will be changeable time to time.
- 12) Kendriya Krishi Vikas Sansthan reserves all institutional rights related to the Investment Policy.
- 13) There is provision of other Forms of investment after the approval from the board of Kendriya Krishi Vikas Sansthan.



## Investment Policies for FDI in Marketing/Sales/Other Division

### Marketing and Sales Division

1. CAGDI Brand development
2. Investment amount consumption in MSP/MOSP purchase
3. FDI Investment amount consumption in supply chain development
4. FDI Investment amount consumption in Loan distribution (Different Based)
5. FDI Investment amount consumption in Land purchase and Construction
6. FDI Investment amount consumption in Human Resource
7. FDI Investment amount consumption in Machineries (Agri/Dairy/Other) purchase
8. FDI Investment amount consumption in Operation of industrial/institutional/educational/other units.

Note: MSP is the Minimum Support Price for Farmers declared by Govt. Of India and MOSP is special price declared by CAGDI at time to time for registered farmers . MOSP will not be less than Minimum Support Price (MSP).

## FDI Allocation on Institutional Consumption Percentage

Sr.No.	Particulars	Type	Percentage (%)
1	CAGDI Brand development	One Time	@2
2	Investment amount consumption in MSP/MOSP purchase (Agri Raw Produce/Product)	Rotational	@40
3	FDI Investment amount consumption in supply chain development	Rotational	@10
4	FDI Investment amount consumption in Loan distribution (Different Based)	Rotational	@2
5	FDI Investment amount consumption in Land purchase and Construction	One Time	@20
6	FDI Investment amount consumption in Human Resource	Rotational	@7
7	FDI Investment amount consumption in Machineries (Agri/ Dairy/Other) purchase	Rotational	@12
8	FDI Investment amount consumption in Operation of industrial/institutional/educational/other units.	Rotational	@7
		Grand Total	100

## Institutional Annual Profit

Total annual profit (cyclic) = @13% by Marketing/Sales unit.

Total annual profit = @2.5% to @3% by finance division

Total annual profit (cyclic) = @7% to @13% by MAPS

Total annual profit (cyclic) = @1.5% to @7% by Grade Scheme

Total annual profit (cyclic) = @3% to @7% by DEDS/Other Milk Based  
Govt. Sponsored Schemes

Total Median cyclic or non-cyclic profit (lump-sum) = @6.7%

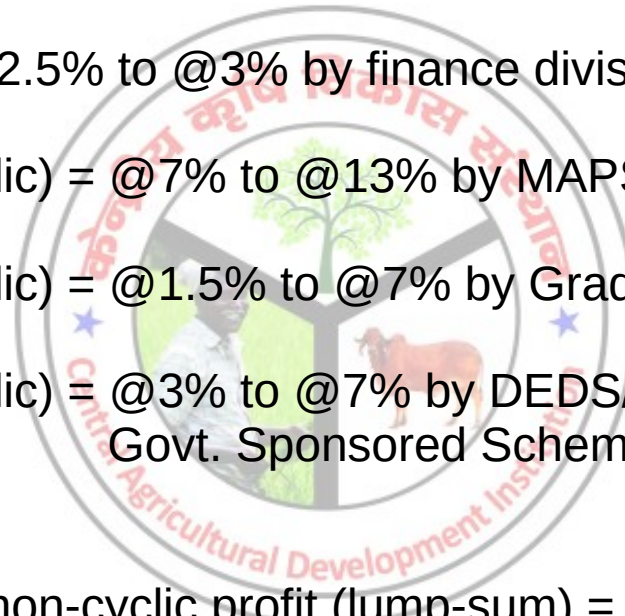

# Investment Policies

## FDI Refund Policy

1. By exporting processed Agri/Medicinal/Dairy and/or Other product or by products.
2. Minimum Foreign Direct Investment (FDI) time are 3 years
3. The minimum interest/profit on FDI are @3% to @5%
4. Returning period of FDI are minimum 7 years to 15 years

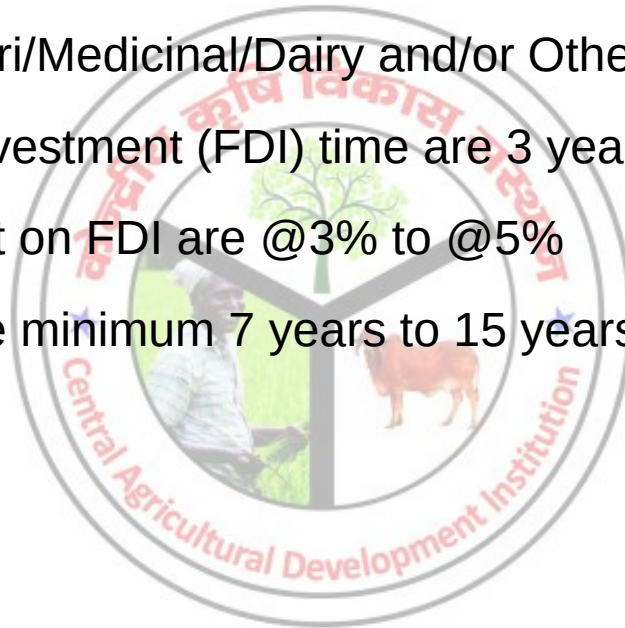



# NNKBGS (Non NPA Krishak Banking Guarantee Scheme)

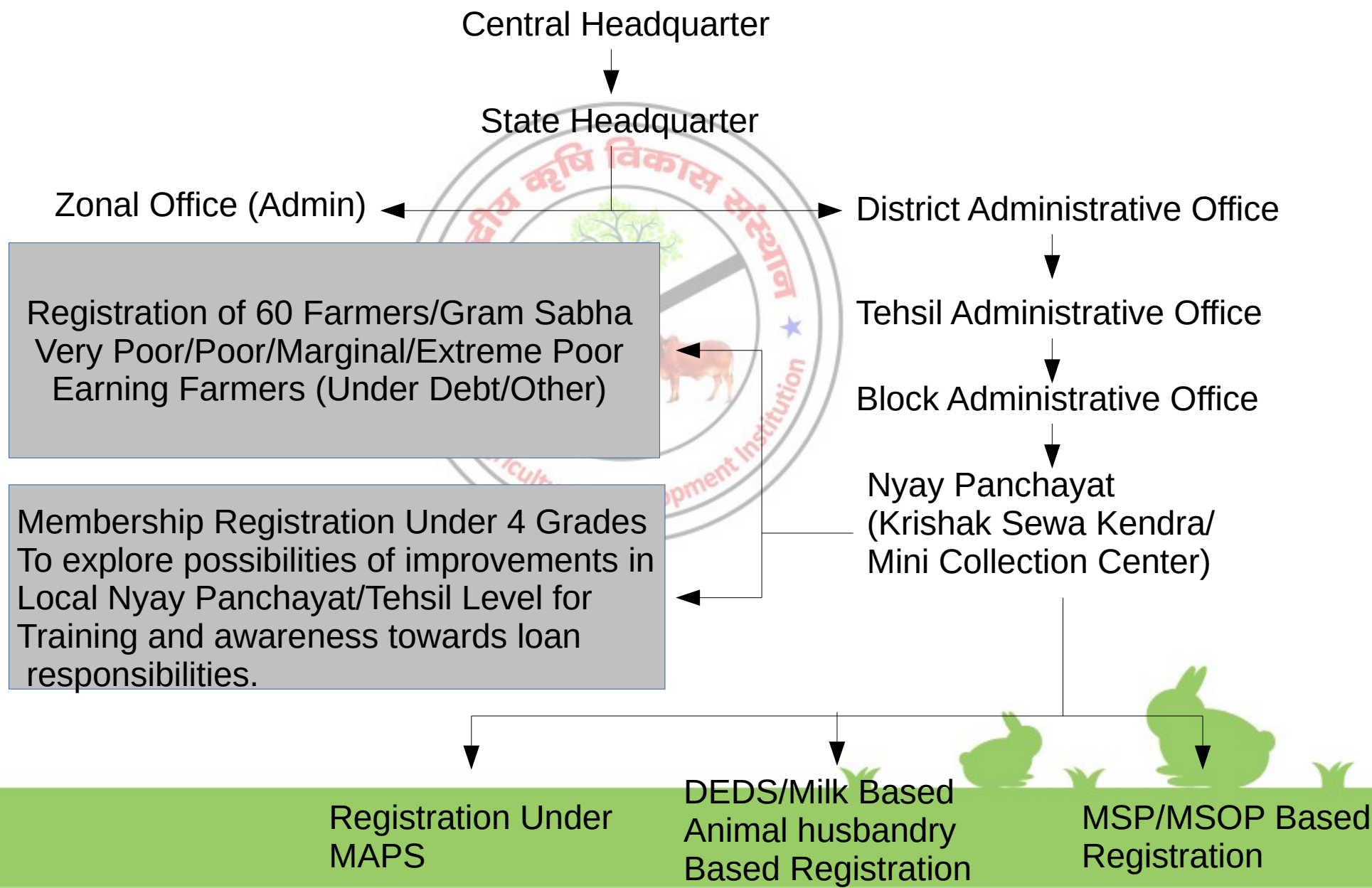

# NNKBGS (Non NPA Krishak Banking Gaurantee Scheme)

1. Trained Farmer under debt or Other Farmers
2. Process of recognition/categorization of Farmer
3. Registration under Grade system
4. Mini loan disbursal
5. EMI or daily recovery process for the mini loan
6. Monitoring of the mini loan performance on daily/regular basis
7. Loan returning (Including Agricultural NPA) in 9 to 12 Months
8. Daily income benefits for @300 per @1000 per @5000 to @50000
9. Loan disbursal @12 months (including Agricultural NPA)
10. Independent Loan distribution
11. Expected earning from independent loan @100000 to @360000
12. Expected earning from independent loan revenue generation @10000/- to @50000/-



# NNKBGS (Non NPA Krishak Banking Gaurantee Scheme)

First Phase action plan for agricultural loan :-

"ऋण एक मनोवैज्ञानिक दशा है |"

CAGDI will develop a flexible, modern information technology solution to counsel, help and support families (involved in agricultural business) in discovering own potential in their local environment.

CAGDI solutions make sure that the beneficiary be in the state of total support from institutional framework to obtain on demand support from existing infrastructure in their local environment (Government or Private) to give 100% performance for loan liabilities.



# Accounts

- Daily Expenses
- Investment tracking
- Balance sheet
- Live WIP status
- Loan status (Institution/Others Debit/Credit Based)



# Accountant Login

- Entry of Opening Balance
- Debit Entry
- Credit Entry
- Day Book



# IT Department

- User Authority Control and Access
- Employee Attendance and HR technical support
- System Configuration
- Nation wide Surveillance (Satellite/Other Base Technology) for Institution/Other Assets or Joint Ventures.
- Satellite Online tracking for Employee/Other.



# Training Program

- (a) NNKBGS (Non NPA Krishak Banking Guarantee Scheme/Schemes) for Employees/Farmers/Others
- (b) ZCBP (Zero Corruption Based Policy) training for Employees/Farmers/Others
- (c) Farmer's power
- (d) Farmer's Skilling
- (e) Training and Adoption of Scientific farming methods.
- (f) Revenue generation by farmers/employees/others in different methods.



Continue.....



# Training Program

(g) Training program of government orders for agriculturist/farmers/employee/others in different methods.

(h) Training of Dairy and Dairy Processing for Farmers/Employee/Others.

(i) Training of Horticulture in different methods for Farmers/Employees/Others.

Training program of Medicinal Agriproducts for Farmers/Employees/ Others.

Continue.....





# Training Program

(k) Training program of grade scheme for Labours (Skilled/Non-Skilled/Semi-skilled)/Employees/Others.

(l) Training program of Agri/other products material management and supply-chain.

The training program will changes at time to time according to Institutional guidelines.



# Institutional Offices (In India)

- Central Head Quarter (CHQ)
- State/UT Head Quarter (SHQ)
- Smart City Offices (Sales/Marketing/Other Units)
- Zonal Administrative Offices/Institution/Assets
- District Administrative Offices/Assets
- Nyay Panchayat Center (Asset)



# CAGDI Working Plan for DEDS

CAGDI will lend small scale units under D.E.D.S. in the state at Zone/Tehsil/District/Nyay Panchayat level.

- CAGDI will setup Processing Units for pure milk.
- CAGDI will setup Dairy Parlours to promote Dairy business in under developed Tehsil/Districts/Nyay Panchayat in a state.
- CAGDI will give employment to Vet Doctors under ZCBP for animal cares at Nyay Panchayat.
- CAGDI will build up a fleet of milk tankers for working states.
- CAGDI lend Wormy Compost units (INR 25200/- per unit) under D.E.D.S.
- CAGDI will lend for hybrid animal for poor and BPL farmers.
- To give direct and tangential employments at village.



# CAGDI Security Unit

- CAGDI will setup unbreakable/unhackable International level Security System **Central Agricultural Industrial Security Force (CAISF)** for units approved by Central or State Governments. Working of CAISF be flexible time to time to keep unbreakable mechanism intact with CAGDI.
- CAISF will provide its supreme protection to following units:
  - Milk and other units of all categories
  - Ware and other houses of all categories
  - Milk and Milk processing unit of all categories
  - Paddy and other processing units of all categories
  - Wheat and other processing units of all categories
  - Pulses and other processing units of all categories
  - Oil seeds and other processing units of all categories



# CAGDI Security Unit

- Potato and other processing units of all categories
- Onion and other processing units of all categories
- Vegetable and raw material processing units of all categories
- Granary purchasing units and other processing units of all categories
- Banking Units
- Communication related Units
- Bima related Units of all categories
- Print and Electronic Media related Units

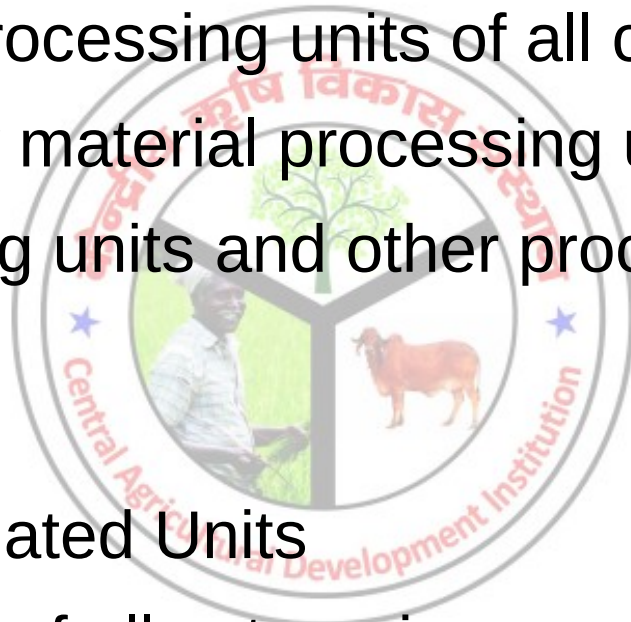

# CAGDI Security Unit

- Various Educational Institutions Including Labs
- Permanent Shelter for Cow and other animals of all categories
- Panchkarma Unit under Ayush
- Processing Units under Ayush establishment

Estimated Employment in CAISF = @ 2739



# HR Management

- Employee Responsibility Allocation
- Wage Allocation
- Salary/Compensation/Other generation on the Basis of Attendance and other inputs.
- Wages + Allowances
- Allowance defined by CAGDI for Travel, Food, Hotel, Cleaning and Others by time to time.

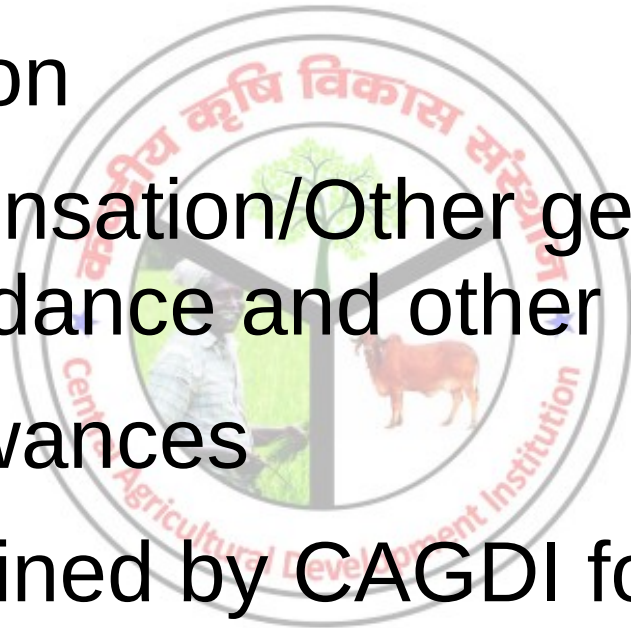

# CAGDI Board/Human Resource Structure

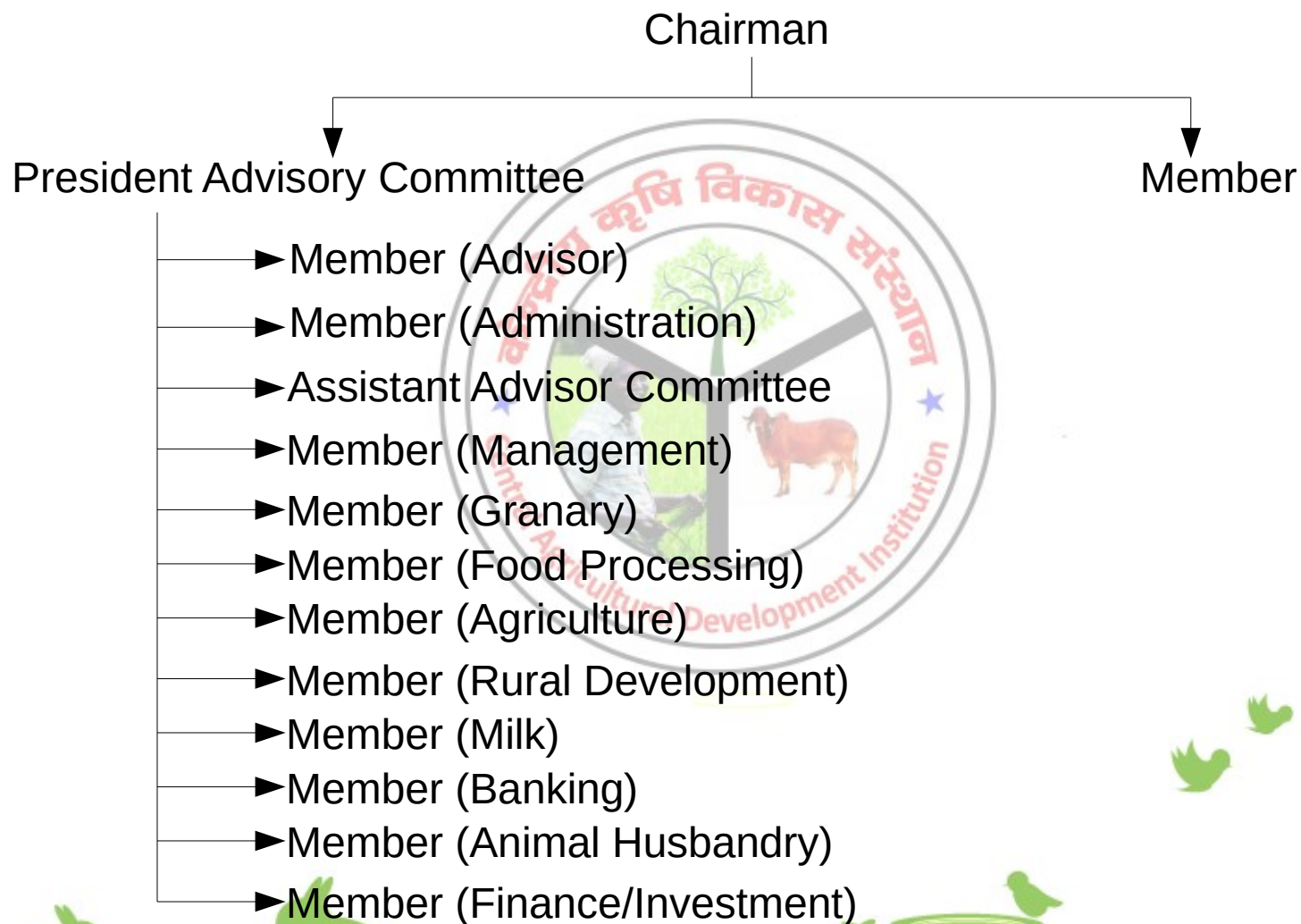

The Board Has All Rights To Decide And Create Contractual/Others Based Posts At Time To Time.



# CAGDI Board/Human Resource Structure

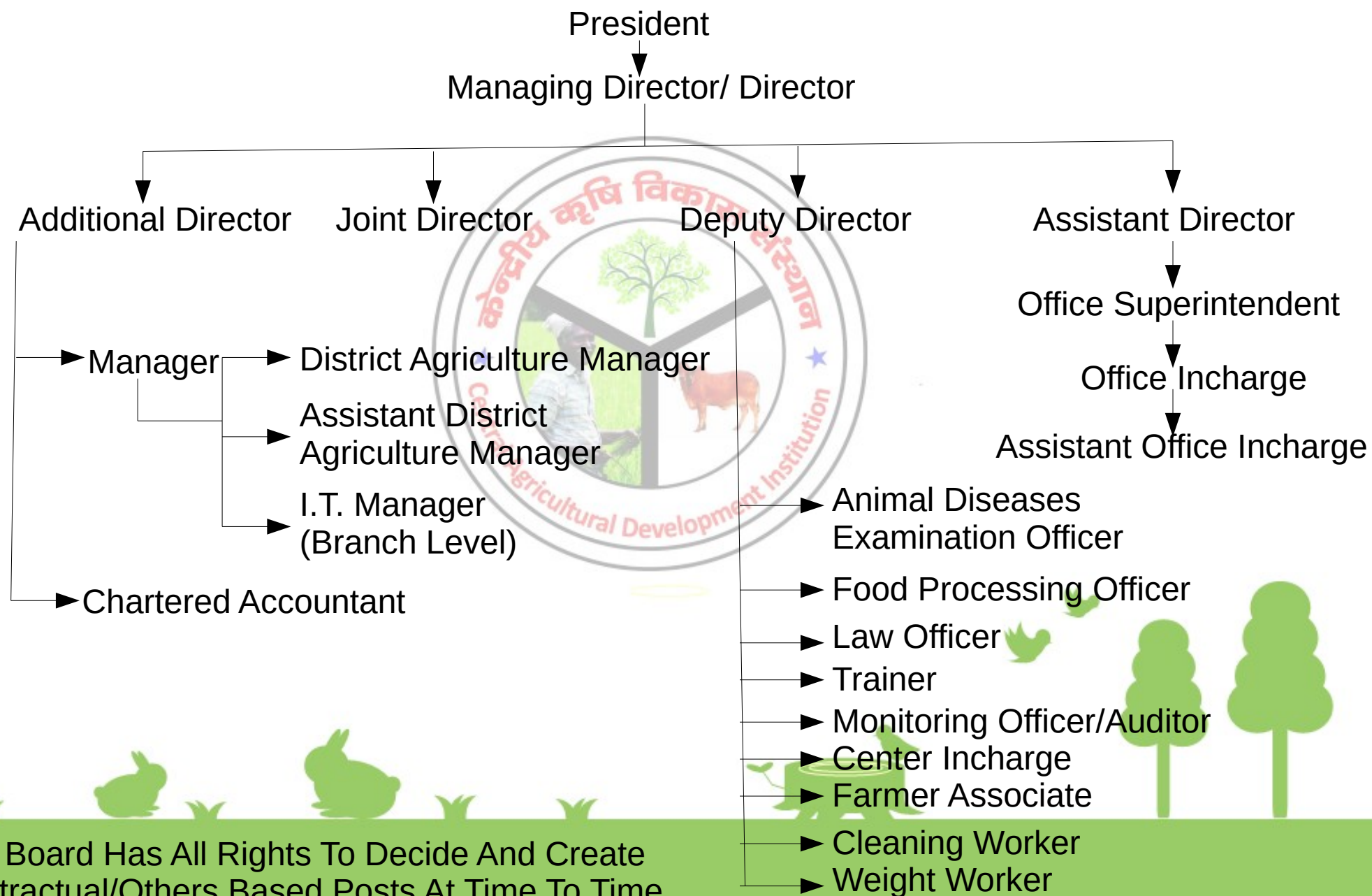

# CAGDI Board/Human Resource Structure

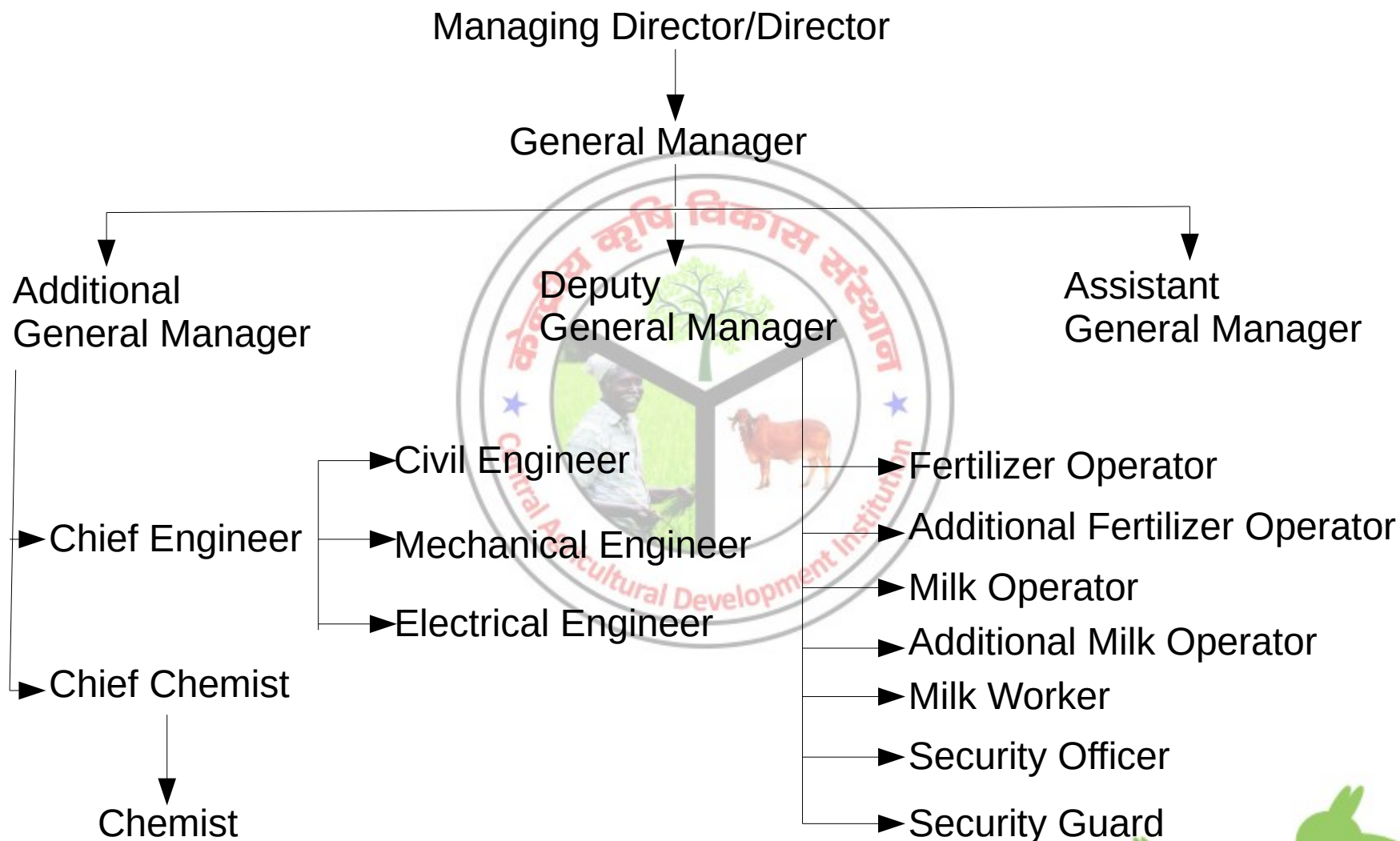

The Board Has All Rights To Decide And Create Contractual/Others Based Posts At Time To Time.

# CAGDI Board/Human Resource Structure



The Board Has All Rights To Decide And Create Contractual/Others Based Posts At Time To Time.

# CAGDI Board/Human Resource Structure

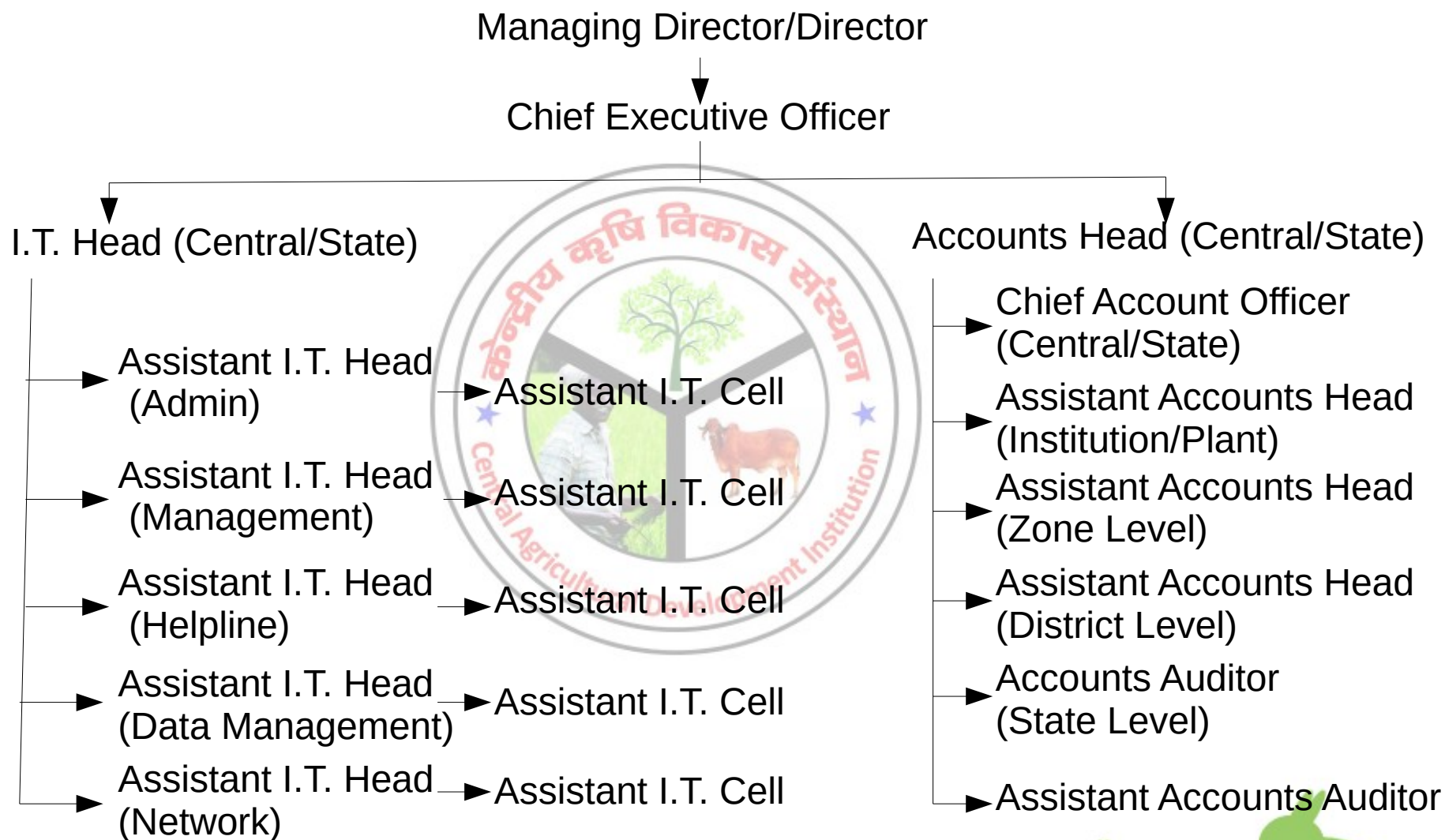

The Board Has All Rights To Decide And Create Contractual/Others Based Posts At Time To Time.

# CAGDI Board/Human Resource Health Cell Structure

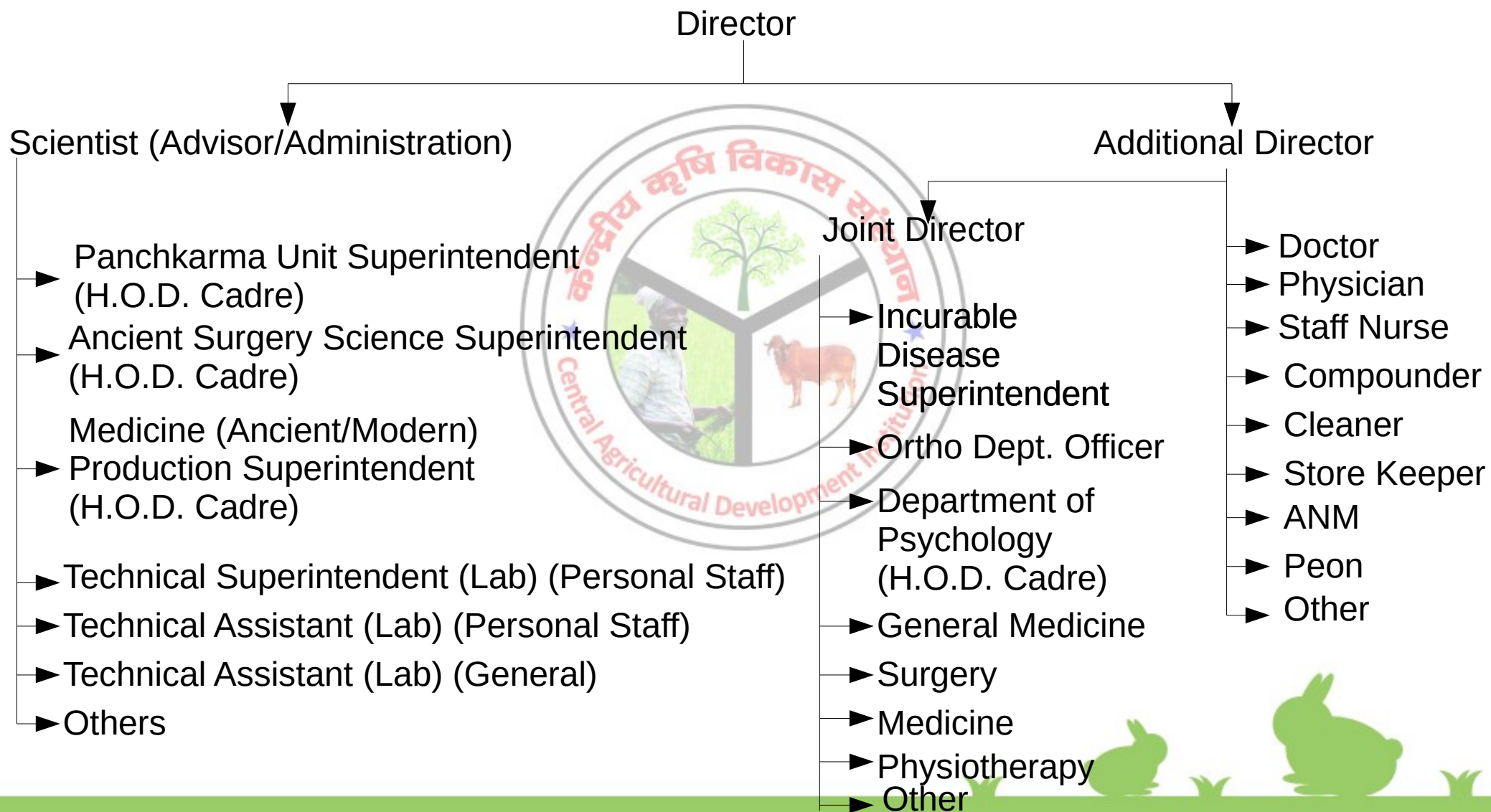

The Board Has All Rights To Decide And Create Contractual/Others Based Posts At Time To Time.

# Distribution/Sales/Marketing Unit Structure of CAGDI

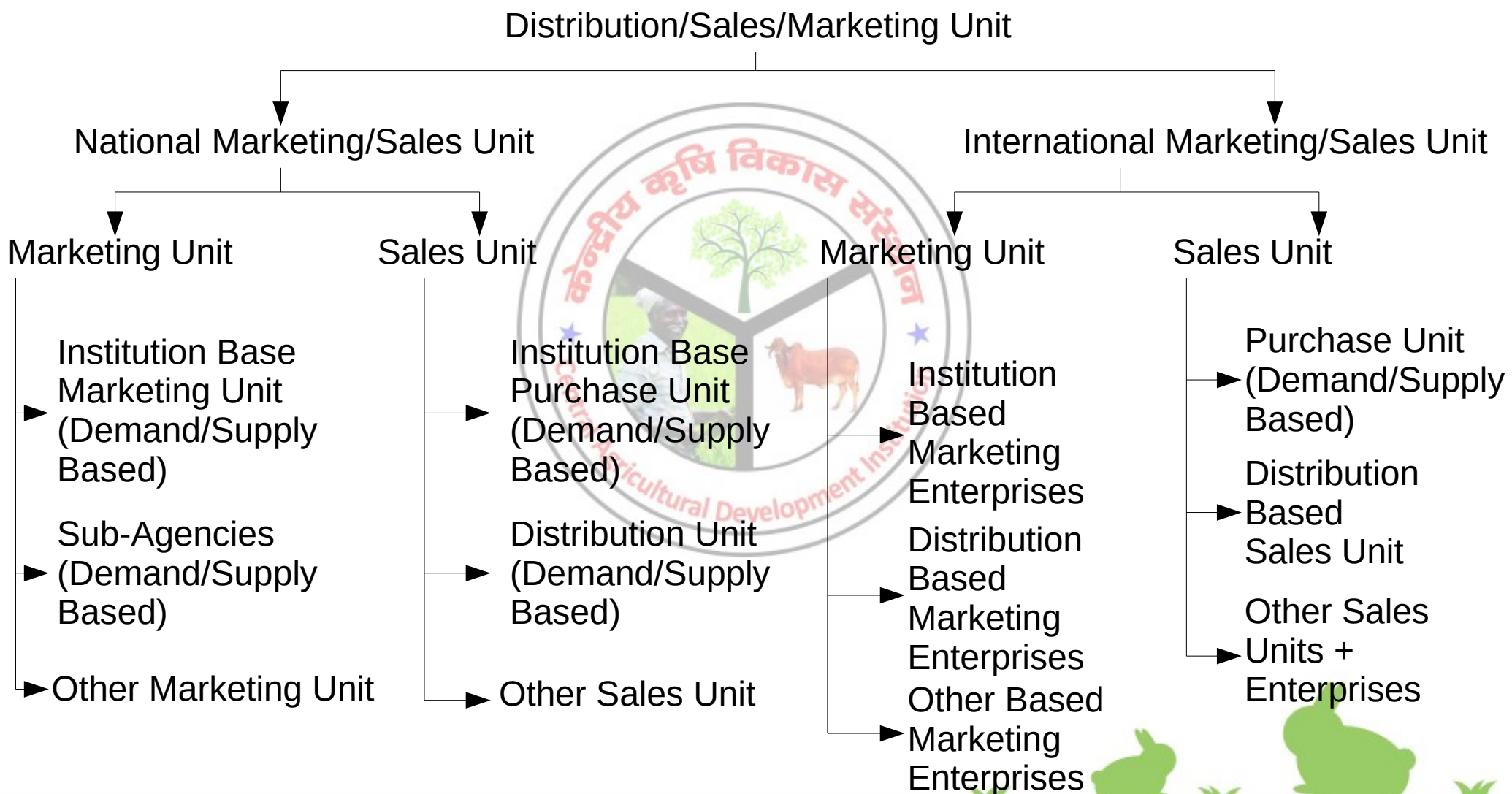

# CAGDI Sales and Marketing

- Estimated details of Sales and Marketing units of CAGDI in India's Smart Cities/Zones/Districts/Tehsil/Block/Nyay Panchayat or Town Area
- Estimated Big Marketing Units =@ 3705
- Employment Opportunity in Big Marketing Units =@ 9,26,250 (250 Employee/Unit)
- Estimated Small Marketing units =@ 7125
- Employment Opportunity in Small Marketing Units =@ 10,68,750 (150 Employee/Unit)
- Estimated Big Small Marketing units =@ 8137
- Employment opportunities in Big small Marketing Units =@ 24,411 (3 Employees/Unit)
- Estimated other Marketing Units =@ 9533
- Employment opportunities in other Marketing Units =@ 1,42,995 (15 Employees/Unit)
- Total Estimated employment opportunity in Sales and Marketing Units of CAGDI =@ 21,62,406 (Twenty One Lakh Sixty Two Thousand Four Hundred Six)



## CAGDI General Unit Employment

Statewise Contractual/Other Based Post in Financial Year 2020-21 to 2024-25 details:

Sr.No.	State	Created Posts Details	Proposed, Contractual/ Other Based Posts	Approved
1	Uttar Pradesh	Administrative/Other, Contractual/ Other Posts	=@ 1,50,000 (One Lakh Fifty Thousand)	=@ 1,50,000 (One Lakh Fifty Thousand)



## CAGDI General Unit Employment

2	Maharashtra, Bihar, Madhya Pradesh, Tamilnadu, Rajasthan, Karnataka, Gujarat, Jharkhand, Chattisgarh, Haryana, Delhi, Andhra Pradesh, Telangana, Orisa, Keral	Administrative /Other, Contractual/O ther Posts	=@ 12,996 (Twelve Thousand Nine Hundred Ninty Six)	=@ 2600 (Two Thousand Six Hundred)
3	West Bengal, Assam, Punjab, Uttarakhand, Himanchal Pradesh, Tripura, Meghalaya, Manipur, Nagaland, Goa, Arunanchal Pradesh, Mizoram Sikkim, Jammu & Kashmir, Laddakh, Puducheri, Chandigarh, Dadar Nagar Haveli, Daman & Div, Andman Nicobar, Lakshadweep	Contractual/ Administrative /Others Contractual based Post or Other Posts	=@ 2600 (Two Thousand Six Hundred)	=@ 2600 (Two Thousand Six Hundred)

# Blue Print of CAGDI Zonal Level Unit

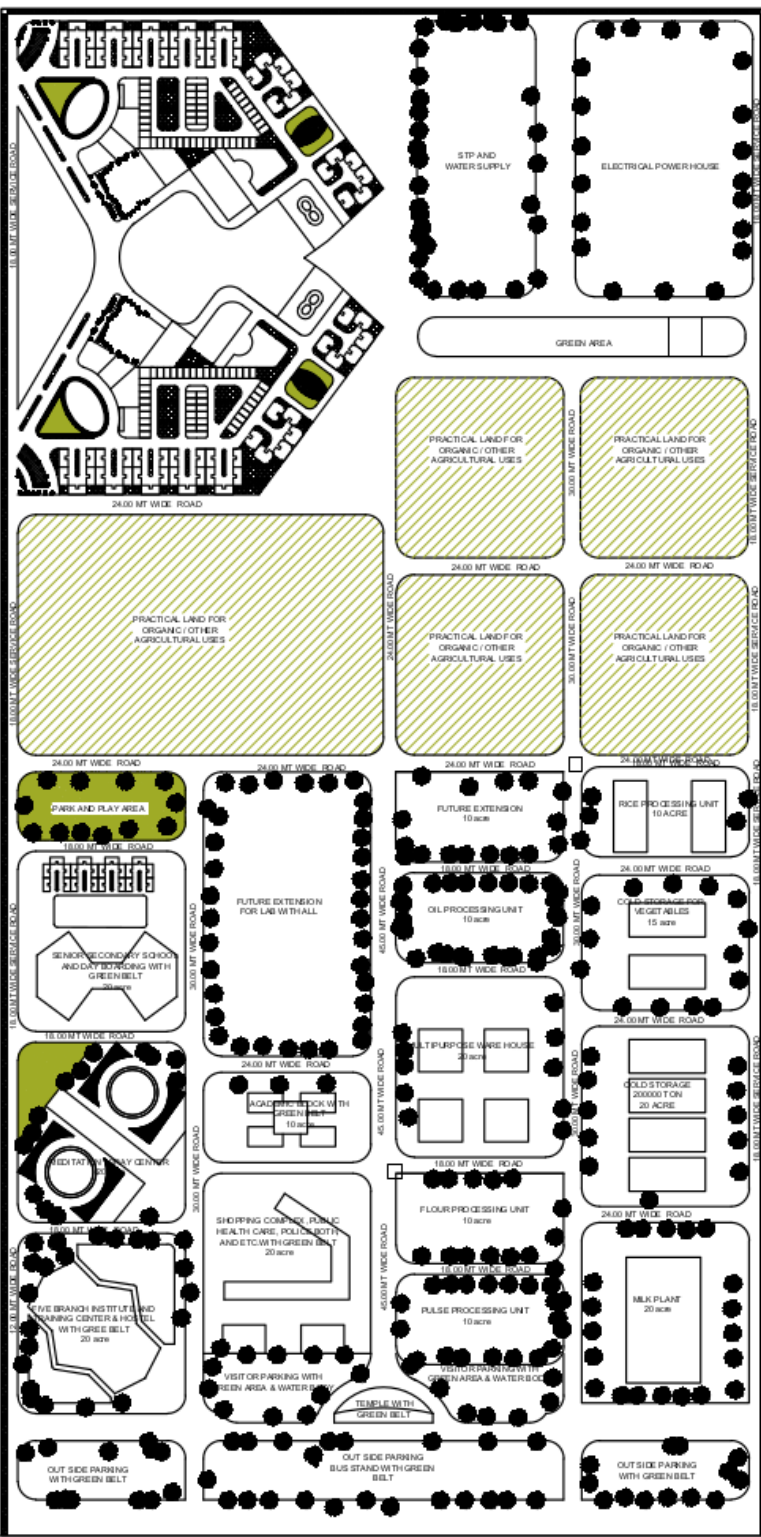

S. NO.	BLOCK NAME
1-	OUT SIDE PARKING WITH GREEN BELT
2-	OUT SIDE PARKING / BUS STAND WITH GREEN BELT
3-	TEMPLE GREEN BELT
4-	VISITER PARKING WITH GREEN AREA
5-	SHOPING COMPLEX, PUBLIC HEALTH CARE,POLICE BOOTH,BANK,ETC.
6-	FIVE BRANCH INSTITUTE AND TRAINING CENTER WITH HOSTEL
7-	MEDITATION CENTER ,YOGA ,SATSANG,MULTIPURPOSE HALL
8-	ACADMIC BLOCK GREEN BELT
9-	L - SHAPE BUILDING SCHOOL,CHILDREN HOSTEL , WARDEN HOMES
10-	PARK AND PLAY AREA
11-	FUTURE EXTENSION FOR SCHOOL GREEN BELT
12-	OFFICERS QUATER,STAFF QUATER & RESIDENTIAL UNITS ,GUEST HOUSE,PLAY AREA,SWIMMING POOL,CLUB HOUSE,GYM,ETC GREEN BELT
13-	UNDERGROUND PRACTICAL LAB
14-	STP AND WATER SUPPLY
15-	POWER HOUSE GREEN BELT
16-	FUTURE EXTENSION FOR MISC GREEN BELT
17-	PETROL PUMP GREEN BELT
18-	COLD STORAGE GREEN BELT
19-	MILK CHILLING PLANT GREEN BELT
20-	COLD STORAGE FOR VEGETABLE GREEN BELT
21-	RICE PROCESSING PLANT GREEN BELT
22-	PULSE RICE PROCESSING PLANT GREEN BELT
23-	FLOUR PROCESSING PLANT GREEN BELT
24-	OIL PROCESSING PLANT GREEN BELT
25-	MULTIPURPOSE WARE HOUSE GREEN BELT



## Blue Print for CAGDI District Level Unit

### Blocks Name:

1. Administrative Block
2. Residential Area for Officers and Worker
3. Small Ware House with Multifunctional Cold Storage.
4. STP and Water Supply (Micro)
5. Truck Parking
6. Weighing Area (Micro)
7. Temple for Meditation and Other
8. Car/Bike Parking
9. Other Future Functional Area



# CAGDI Cow Shed Proposal



# CAGDI Cow Shed Proposal

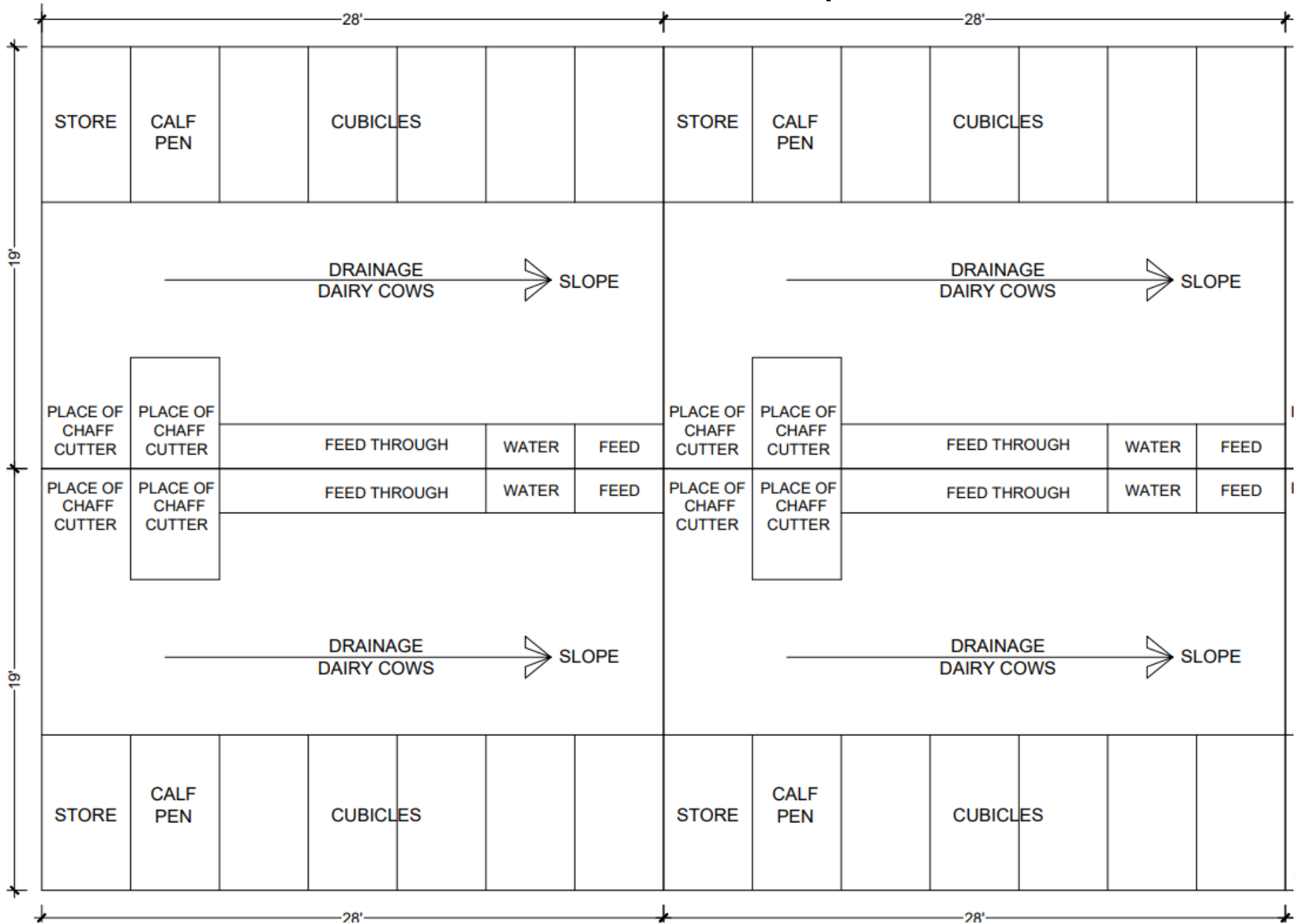

## CAGDI Proposed Cow Shed Exterior

This is a place for the cows to relax and sleep during the night.

Each cow has their own place in the resting area, called cubicle.

The cubicles must be covered with a roof made of iron sheets (Mabati), grass thatch or makuti.

The roof must be high enough so that it cannot be eaten by a cow if it is made of grass or if hay is stored under it.

The cubicle should be constructed such that the cow remains clean all the time. Clean the cow shed every day.

A rough concrete floor will stop the cow from slipping. A sloping floor will help waste to drain away. Collect it outside the shed.

Clean and disinfect the floor every day. This stops foot rot and abscesses.

A cow needs space to lie down. One should construct the number of cubicles enough to be occupied by animals most of the time. Unoccupied cubicles are a waste of space and money.

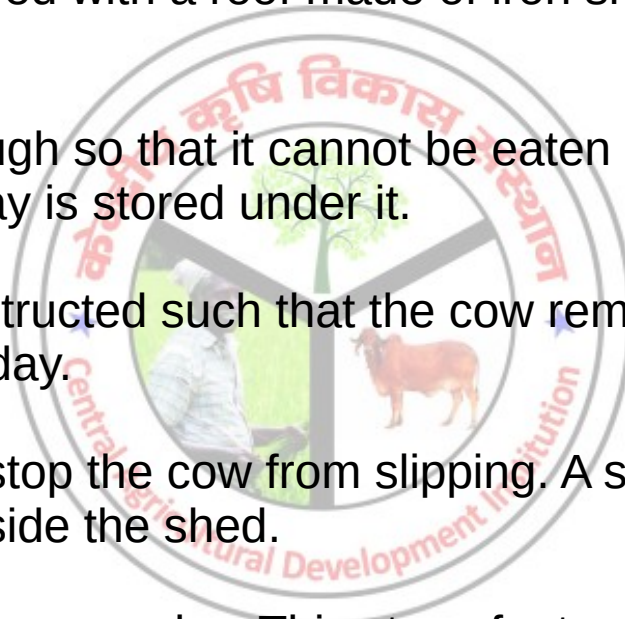

## CAGDI Proposed Cow Shed Interior

For a given number of cows to a unit, extra cubicles are required to house young-stock (heifers) eg

=@1 cow =@2 cubicles  
 =@2 cows =@3 cubicles  
 =@3 cows =@5 cubicles  
 =@4 cows =@6 cubicles  
 =@5 cows =@7 cubicles  
 =@6 cows =@9 cubicles

A cubicle has a length of =@210 cm (7ft) and a width of =@120 cm (4 ft).

Cubicles are separated from each other by =@2 timbers.

The cow should not be able to turn around in the cubicle.

Feeds in troughs at least =@3 ft above the ground.

Fix a mineral block to each cubicle to limit fighting between the animals.

Your cow must always have clean water. Catch rainwater off the roof.

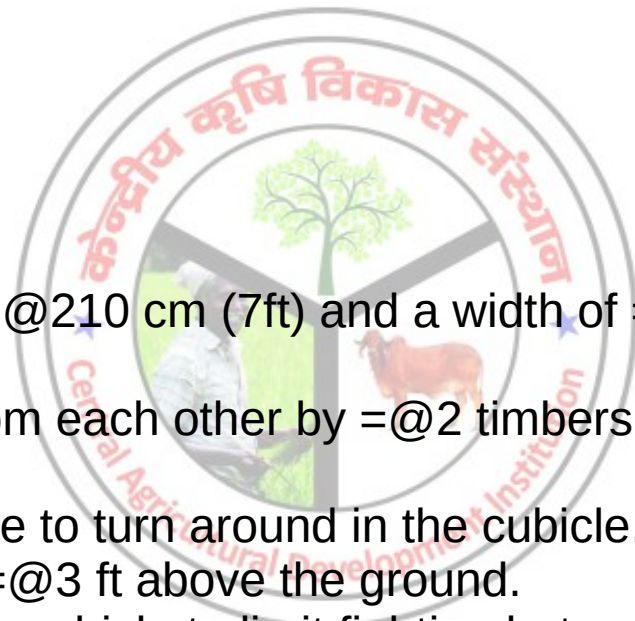

# CAGDI Proposed Cow Shed Final Layout

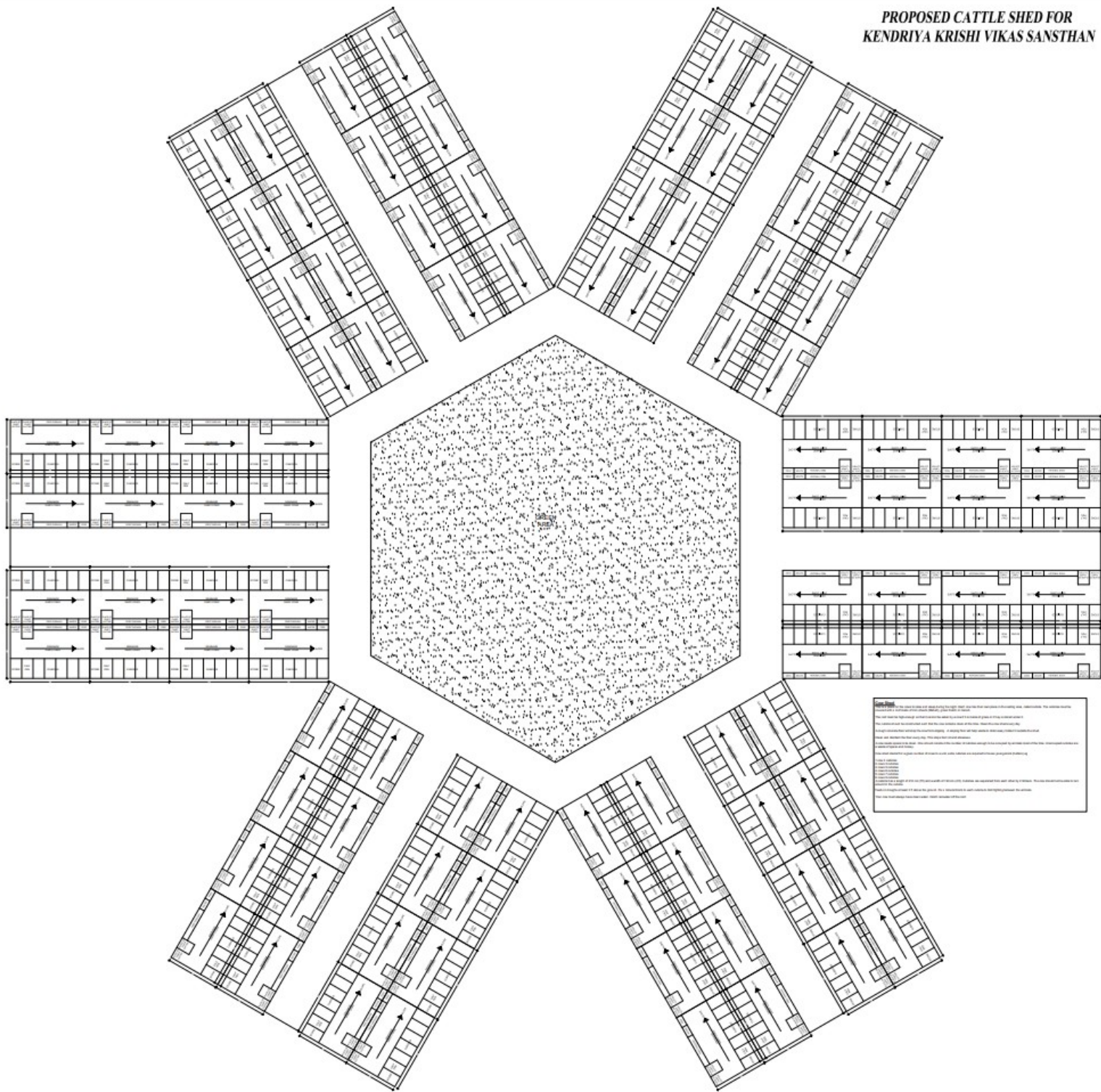



Note: Kendriya Krishi Vikas Sansthan (CAGDI) has All Rights Reserved for Decided/Created Or Declared Contractual/Others Based Posts and Other Decision To Make And Create At Time To Time.

